



VIBES

MD850

OWNER'S MANUAL



Content

Content	1
Foreword.....	4
Readers Guide.....	4
Disclaimer.....	5
Versioning	5
General safety instructions.....	6
Suitable installation location.....	6
Mains connection.....	6
Intended use	6
Maintenance	7
Data.....	7
Repairs	7
Disposal.....	7
Connectivity	8
Rear connections	8
Commissioning.....	11
Panel Overview and Operating Concept.....	13
Main Section	14
One Knob Section.....	16
Parts Section	17
Macro Section	17
Filter Section	18
Voice Navigation Section	18
Synthesizer structure	19
Data Structure.....	20
PERFORM (Performance).....	22
Loading a Performance	22
Filter Performances.....	22
Saving a Performance	23
Editing a Performance.....	23
Managing Performances.....	24
MIXER.....	25
Schema.....	26
Input Stereo Channel	27

Split Input Stereo Channel	29
Group Control	30
Output Stereo Channel	31
Split Output Stereo Channel	32
FX 1,2 Effect Channel	32
Voice structure.....	34
Extended features.....	34
Voice- shutdown	34
PART A (B, C, D).....	36
Loading a Preset.....	36
Filter Presets	36
Saving a Preset	37
Editing a Preset	37
Deleting a Preset.....	38
Managing Presets.....	38
Variants	38
CFG A (B, C, D).....	40
VOICE A (B, C, D)	42
OSCILLATOR Wavetable Mode.....	43
Wavetable Selection	43
OSCILLATOR Algorithm Mode	46
Parameters:.....	46
OSCILLATOR Resonator Mode	48
OSCILLATOR Configuration	50
OSCILLATOR Multisample Mode.....	52
SHAPER.....	54
MIX	56
FILTER A(B)	57
LFO 1(2,3).....	59
User defined LFO.....	61
ENV (Envelope Generators)	62
MOD (MODULATION – MATRIX).....	64
Signal Summing.....	65
Signal Animation	65
ARP A (B, C, D) (Arpeggiator)	69
SETTINGS.....	70

ASSIGN	70
MODE	71
SEMITONE	72
OCTAVE	72
VELOCITY	73
CVA (B, C)	73
SEQ (MIDI-Sequencer)	74
IMPORT	74
VIEW	74
CONFIG	75
DRUM (Sample-Player)	76
KIT	76
GRID	77
INSTRUMENTS	80
CLIP (Clip-Launcher)	82
MIDI (MIDI Settings)	86
MIDI Clock	86
MIDI Devices	88
MIDI Inputs	88
SETUP	90
DIAGNOSTIC	90
WIFI	91
Export / Import	93
USB	93
Web Interface	93
Software Updates	94
Online Update	94
USB Update	94

Foreword

Thanks for purchasing the Vibes MD850 Synthesizer. You are now owner of a handcrafted synthesizer with astonishing features and sound capabilities. We are proud to be able to call our product made in Austria, produced with local suppliers mainly from Austria and Germany. This way we can guarantee the highest quality standards.

We wish you a lot of joy and fun, creating amazing sounds with the Vibes Synthesizer.

Horst Mayer & Team

Readers Guide

We have tried to develop a synthesizer which is intuitive to use by using terminologies and words, well known in the world of electronic music. Nevertheless, a synthesizer remains a complex but also powerful instrument. Therefore, we strongly recommend to read this manual to get the most out of your Vibes MD850 and also discover the not so obvious features.

While introducing the connectivity and commissioning of the device in the first chapters, you will find more information about the software as the main part of this manual. Therefore, this manual is structured according to the display menu structure of the Vibes MD850 for easy orientation. The manual finishes with the last chapters with information about updates and further support possibilities. We wish a lot of fun while experimenting with your new Vibes MD850.

Disclaimer

A lot of care has been taken in the preparation of this manual to exclude errors and inconsistencies. We apologize in advance for any errors and mistakes.

Nevertheless, Mayer-EMI assumes no responsibility or liability for any errors or omissions in the content of this document. The information contained in this document is provided on an "as is" basis with no guarantees of completeness, accuracy, usefulness or timeliness.

The content of this manual is subject to change without notice.

This manual may not be reproduced, in whole or in part, without the permission of the manufacturer.

Mayer – EMI GmbH, Franz Prendingerstrasse 74, 2540 Bad Voeslau, Austria



Versioning

Please be aware, that the Vibes MD850 is a software synthesizer, which allows you to update its functionality during its lifetime. Therefore, every description of the software within this manual refers to a specific software version and may not be valid or different in any other software version. Please make sure you are reading the manual according to the same software version of your synth. To check which version you are running, please refer to chapter *DIAGNOSTIC*



This Version of the manual is written for the
Software Version 3.00 A

General safety instructions

 <p>CAUTION</p>	<p>Read and follow all safety and operating instructions carefully before using the device. Follow all warnings and safety instructions attached to the device and noted in this document.</p> <p>Read the whole document before using your device.</p>	
---	---	---

Suitable installation location

- Only operate the device in closed rooms and avoid moisture and dust.
- Ensure an unobstructed air supply to all sides of the device. Do not install the device in the immediate vicinity of heat sources.
- Do not expose the device to direct sunlight or strong vibrations.
- Choose a stable installation location to prevent the device from falling.

Mains connection

- Only use the power supply unit included in the scope of delivery. This power supply unit is designed to supply the device and the devices connected to the USB 2.0 host (with a maximum total of 1.5A).
- Only use the country adapters (EU / UK / US / AU) that are suitable for your mains supply and are supplied with the power supply unit. If none of these adapters are suitable for your mains supply, do not use the device and contact your dealer.
- Only use the supplied mains adapter for this device.
- When connecting and disconnecting the device, only pull and push on the plugs and never on the cable.
- Avoid bending or twisting the connection cable of the power supply unit. Furthermore, do not place any heavy objects on the connection cable of the power supply unit. This can lead to damage or short circuits.
- Before a thunderstorm, disconnect the power supply unit and any network cables etc. connected to the device from the connection sockets to protect the device from damage caused by lightning or overvoltage.

Intended use

- The Vibes MD850 is intended exclusively for generating and processing audio signals and control signals in accordance with the MIDI standard or USB 2.0 MIDI devices such as controllers or keyboards. Any other use is not permitted and excludes any warranty claims against Mayer EMI GmbH.
- In combination with amplifiers, headphones or speakers, this device and the software on it can generate volumes that can temporarily or permanently impair your hearing. Therefore, do not operate them at a high or uncomfortable volume level for a long period of time. Ensure that all connected devices are set to a low volume level before switching on.
- Prevent any objects (e.g. flammable materials, coins, needles, etc.) or liquids of any kind (e.g. water, drinks, etc.) from entering the device.
- Avoid exerting excessive pressure on the display of the device.

- Switch off the device immediately, disconnect it from the mains immediately and contact your dealer before restarting it if any of the following occurs:
 - The connection cable of the power supply unit is damaged
 - The appearance of smoke or unusual odours
 - Ingress of any objects or liquids into the device
 - The device has been exposed to rain and has become wet in any way

Maintenance

- Before cleaning, disconnect the device from the mains and remove all plugged-in devices.
- Only use a soft, dry cloth for cleaning
- Do not use any liquids such as alcohol, acetone etc. for cleaning.
- Avoid applying excessive pressure to the display during cleaning.

Data

- Please note that the memory content of the device can be irretrievably lost at any time due to a malfunction or improper operation of the device. To protect yourself from the risk of losing important data, we recommend that you make regular back-up copies of this data on external media. Mayer EMI GmbH is not liable for data loss of any kind.

Repairs

- Do not carry out any repairs or other modifications to the device yourself. Always take the device to an authorized specialist dealer for repair.
- Opening the device by yourself is prohibited and will invalidate the guarantee and warranty.

Disposal

 RoHS	<p>The device complies with European directives 2014/35/EU, 2014/30/EU and 2009/125/EU. At the end of its life, this product may not be disposed of in normal household waste, but must instead be taken to a collection point for recycling electrical and electronic appliances. The materials are recyclable in accordance with their labelling. Reuse, recycling and other ways of reutilizing old devices make an important contribution to protecting our environment.</p> <p>Please ask your dealer or local authorities for information about the appropriate disposal point.</p>
--	---

Connectivity

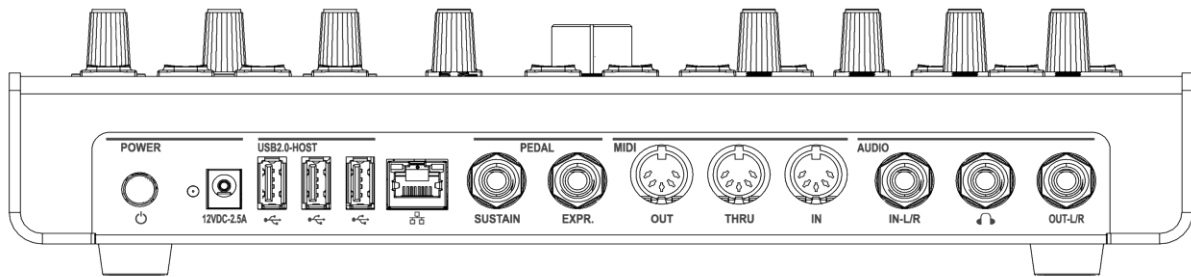

Rear connections

- 1 Power switch & indicator light
- 2 Power connector
- 3 USB 2.0 Host connectors
- 4 Ethernet connector
- 5 Pedal connectors
 - Sustain/Hold Pedal
 - Expression Pedal
- 6 DIN-MIDI connectors
 - MIDI Out
 - MIDI Through
 - MIDI In
- 7 Audio connectors
 - IN-L/R Stereo Audio Input (6.35mm)
 - Stereo Headphone Output (6.35mm)
 - OUT-L/R Stereo Main Output (6.35mm)

USB 2.0 Host connectors

The Vibes MD850 is equipped with three USB-A connectors with USB2.0 Host functionality. These USB ports allow the connection of MIDI "class-compliant" keyboards or controllers. The connected devices are managed in the MIDI menu (see chapter *MIDI (MIDI Settings)*).

Supported Keyboards

- All MIDI class-compliant Keyboards

Supported Launch Pad Controllers

- Novation Launchpad Pro MKII
- Akai Professional APC Mini MK2
- Akai Professional APC Mini Pad Controller

USB- Mass storage

The connection of USB standard mass storage devices like USB sticks and SSDs is possible. Those can be used to export or import Performances/Presets/Samples/Wavetables and more (see chapter *Export / Import*).



INFO

Only mass storage devices with FAT/FAT32 formatted file systems are supported.

All other kinds of USB functionality (e.g. connecting Audio Interfaces, etc.) are currently not supported. Therefore, don't connect any USB Devices which do not belong to one of the categories mentioned above to these ports.

Pedal Sustain/Hold

A pedal (normally open or normally closed) can be connected to this mono jack socket. When switching on the Vibes MD850, the polarity of the released pedal is sampled, so that pressing the pedal triggers the Sustain/Hold function regardless of the polarity of the pedal.

- **Sustain:** Selects between two different release times.
- **Hold:** Holds the sustain phase regardless of the release of the keyboard keys.



INFO

The pedal should not be pressed when switching on the Vibes MD850, otherwise the corresponding polarity will not be recognized correctly.

Ethernet

This RJ45 Ethernet jack allows to connect to a 100Mbit Ethernet Network.



INFO

Currently there is no software configuration available for this connection. Make sure, the network provides proper IP settings via DHCP in case you want to use this port

MIDI IN

This DIN MIDI input jack allows the connection of a MIDI keyboard or controller according to MIDI 1.0 specification.

Controlling the "Drum Sampler (see chapter *DRUM (Sample-Player)*) is possible via MIDI channel 10.



INFO

For further information about configuration of MIDI Devices, Clocks, etc. please refer to chapter *MIDI (MIDI Settings)*

MIDI THRU

This DIN MIDI output jack, according to MIDI 1.0 specification, forwards the signals received on MIDI input without delay.

MIDI OUT

This DIN MIDI output jack, according to MIDI 1.0 specification, is used to connect external sound generators.

AUDIO IN

This 6.35mm stereo jack (TRS) is an audio input which can be mixed into the Vibes MD850 audio output via the digital Audio Mixer.

AUDIO OUT

This 6.35mm stereo jack (TRS) is the main audio output to be connected to your external mixer, amplifier or active speakers.

Commissioning

Connecting Schema

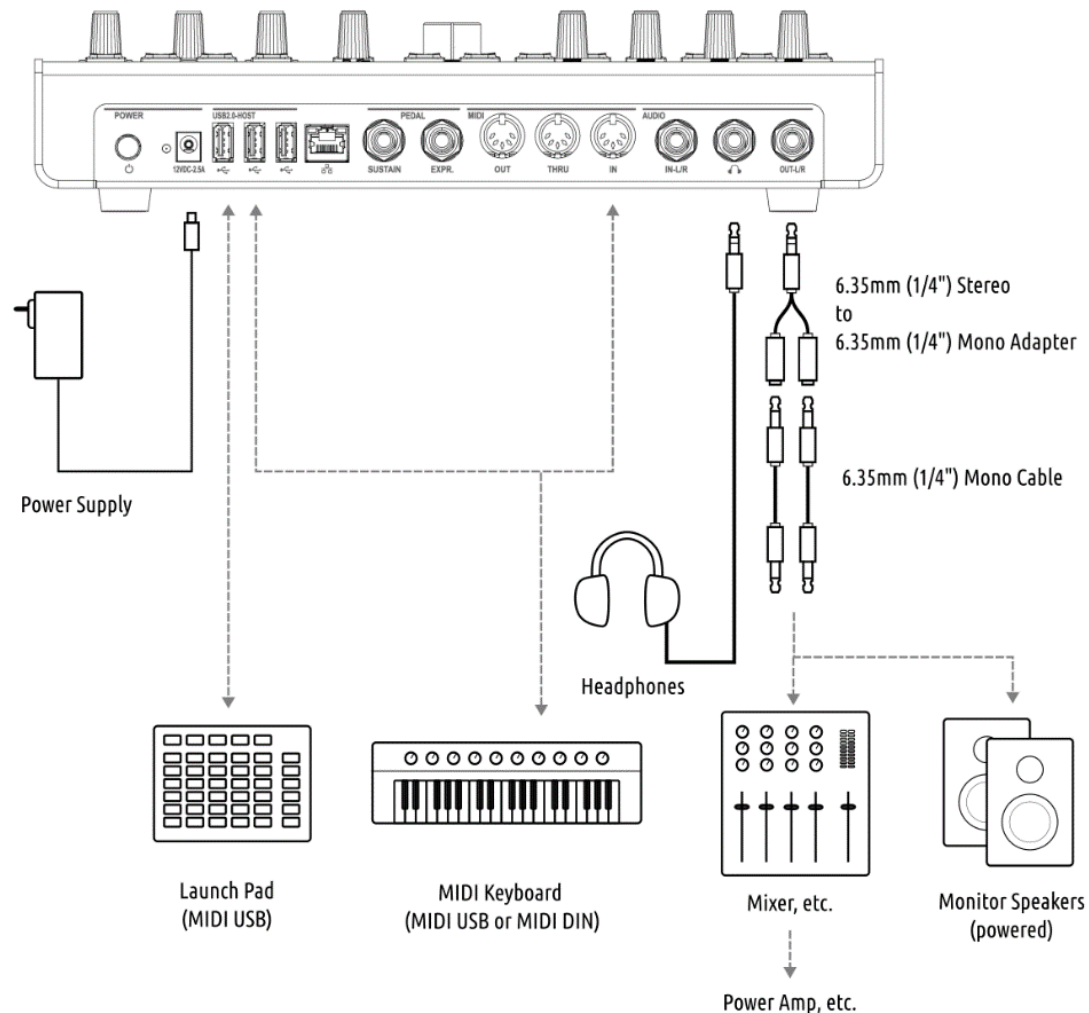

Connecting the Unit to Power

Make sure the power switch is in the OFF position before connecting the device to Main Power. Before switching the unit on, please lower the volume of your speakers or mute the input channels on your mixer to prevent any damage to your speakers or ears.

Put the country adapter suitable for your country on the Power Supply.

Use only the power supply and adapters that were shipped with your Vibes MD850. Plug the Power Supply into the mains socket and into the DC Power Jack on the Vibes MD850 rear panel. Continue with connecting other devices as explained below, before switching on the power.

Connecting an Audio System

After muting the channel inputs or lowering the volume of your speakers, connect a 6.35mm (1/4") stereo cable or from the rear panel output jacks of the Vibes to the inputs of your mixer, monitor speakers, etc. Alternatively, you can use the stereo to mono adapter included in the delivery and use

a dual 6.35mm Mono Cable instead. Continue with connecting other devices before switching on the power.

Note: The USB Host or Ethernet jack do not provide any audio output.

Connecting Headphones

Make sure the headphone volume control in the Mixer menu is turned to its lowest setting before connecting the headphones.

Connect the headphones to the according 6.35mm (1/4") headphone output at the rear panel of the Vibes MD850.

Adjust the headphone volume in the Mixer menu (Mixer -> Master -> Headphones) on your Vibes MD850 to your needs.

Connecting DIN MIDI Keyboards

The Vibes MD850 has three 5-pin MIDI DIN connectors to allow you to interface with other MIDI devices. MIDI OUT sends data from the Vibes, MIDI IN receives data, and MIDI Thru passes data from the MIDI IN without any modifications.

Make sure to configure the MIDI channels on your Input Devices appropriately or configure the MIDI channel settings in the MIDI menu on the Vibes MD850. (see chapter *MIDI (MIDI Settings)* for more details)

Connecting USB MIDI Keyboards / Controllers

The Vibes MD850 has three USB-A Host jacks to allow you to interface with USB-MIDI Devices. Each port is able to supply a maximum current of 0.5A (1.5A in total) to connected Devices. Each port is equal in its functionality and supports standard USB-MIDI keyboards and a selected range of Launch Pad Controllers without the need of any driver installation.

After connecting the USB-MIDI Device find and configure it in the MIDI-Device Menu (MIDI -> Devices) of your Vibes MD850. Make sure to configure the MIDI channels on your Input Devices appropriately or configure the MIDI channel settings in the MIDI menu on the Vibes MD850. (see chapter *MIDI Devices* for more details)

Turning on the Unit

Make sure the volume controls on all connected devices are on their lowest settings before turning on the Vibes MD850.

Turn on the Power Switch located on the rear panel of the Vibes MD850.

Wait for the Vibes MD850 to start up and show the startup screen in the display.

You are ready to create your sounds starting with the automatically loaded Performance.

Panel Overview and Operating Concept

The Vibes MD850 front panel allows the interaction with your Vibes MD850. It is equipped with a big 5" capacitive touch screen to get feedback of all different parts of the sound engine and allow modification of its parameters. Physical encoders and buttons allow quick and precise modification of important parameters without the need of using the touchscreen.



The Front Panel can be divided into the following sections:

1. Main Section
2. One Knob Section
3. Parts Section
4. Macro Section
5. Filter Section
6. Voice Navigation Section

Main Section

The Main Section consists of the Main Display, 4 Encoders, a Selection Encoder and Quick Navigation Keys. The whole section acts as a unit, by allowing the modification of parameter values shown on the display via the physical rotation of the encoders. Together with the Quick Navigation Keys which offer an alternative to switch the Main Menu Pages it improves usability and easy navigation.

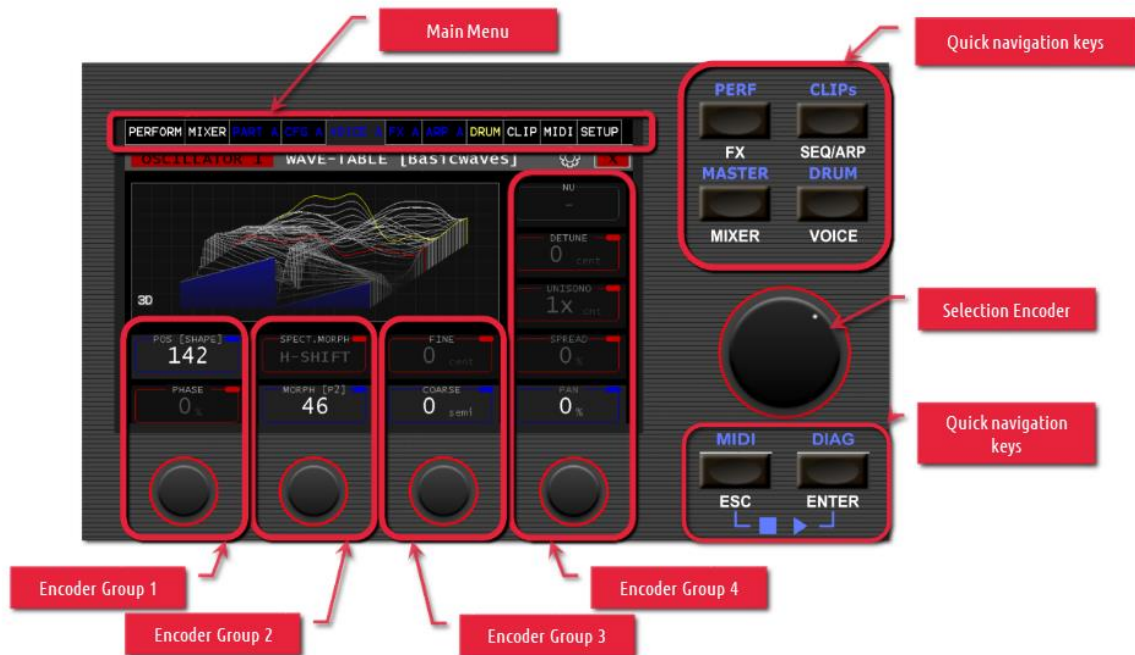

Main Menu

The main menu is always located in the upper display area. It allows for easy access via the touch screen. When touching a main menu tab, the according page will be opened. Some pages are structured via an additional sub menu.

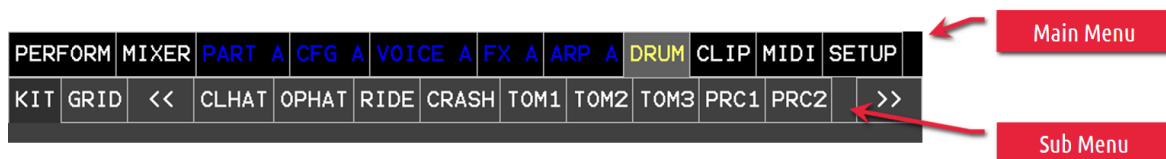

Alternatively, the Main Menu Pages can be accessed by the Quick Navigation keys without the need of using the touchscreen.

Quick Navigation Keys

Pressing the Quick Navigation keys will open the according primary Main Menu Page (White caption Text). Holding the Quick Navigation keys (more than 800ms) will open their secondary Main Menu Page (Blue caption Text).

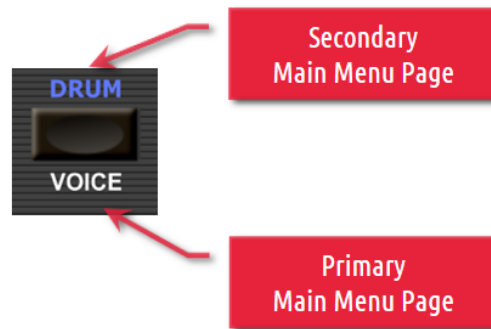

Selection Wheel

The Selection Wheel is used for scrolling and selection. Turning the knob, will scroll through lists, while pressing the knob will activate a selection.

The exact function of the Selection Wheel is depending on the active page and is explained in the corresponding chapters of this document.

Pressing the ESC + ENTER key at the same time starts/stops all currently playing arpeggiators, sequences or drum patterns.

Encoder Groups

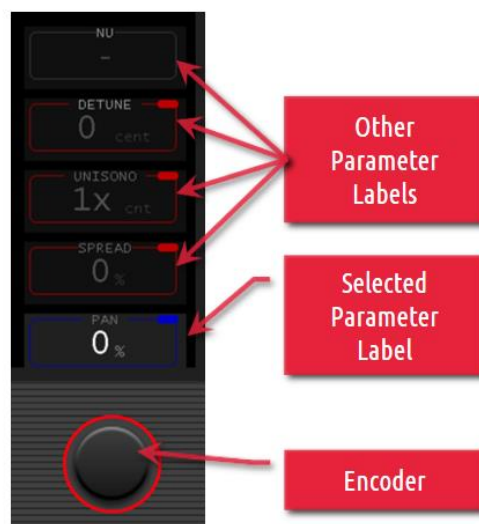

Encoder groups are the vertical alignment between the on screen parameter labels and their corresponding physical encoder knob on the front panel.

There are 4 encoders, therefore also four encoder groups. Each encoder knob is controlling up to 5 values on the corresponding on screen parameter labels. Since the encoder can only modify one parameter label value at a time, a touch on the parameter label of a group selects it as the active parameter label to be modified with the encoder of the encoder group.

Parameter Label

The parameter label shows the Name, Value and Unit of a given parameter. It can either be active (blue frame) and reacting to changes via the encoder or inactive (red frame) only showing the current value.

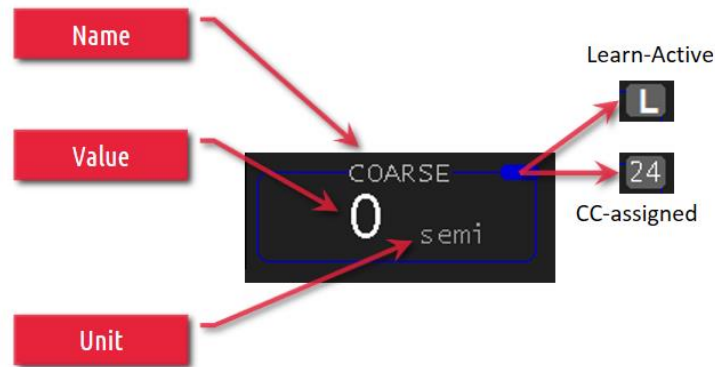

MIDI Learn

If the LABEL has a blue marking in the upper right corner of the frame, the "MIDI Learn Mode" can be activated by touching and holding for more than 3 seconds. This is indicated by "L". If now a control signal is received from one of the connected MIDI ports, the assignment to this parameter is done and an automatic scaling is performed. Now the CC number is displayed. Pressing and holding again (> 3 sec) deletes the assignment or ends the "MIDI Learn Mode".

One Knob Section

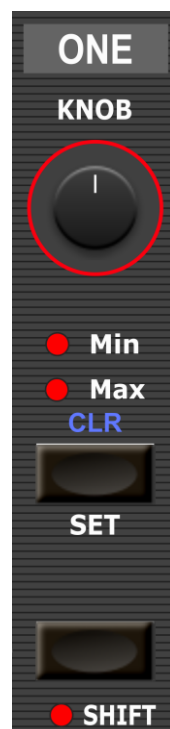

The One Knob Section allows to configure and morph multiple Parameters (with individual ranges) together by turning the ONE KNOB.

In difference to the Macro Section, which is only able to modulate parameters in the currently active Part, this knob can also morph Parameters from inactive Parts.

Parts Section

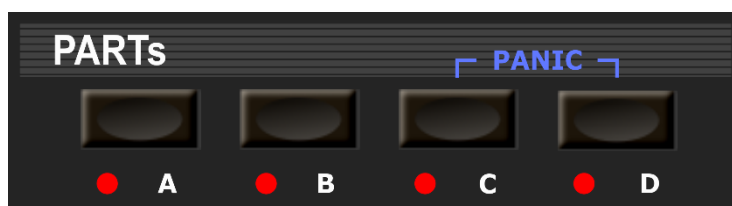

The Vibes MD850 is equipped with 4 independent sound engines so called PARTs. This enables you to play four different sounds simultaneously. In that case the four PARTs will share a common pool of 24 stereo voices. The assignment of voices to the different PARTs will be handled dynamically by the Vibes MD850.

The PARTs Section Allows to switch between those 4 independent PARTs (A, B, C and D) by pressing the according button, while signaling the currently active PART via the according LED. Additionally, the currently active Part is visible by the Color of the LED Encoders in the Macro and Filter Section, as well as on the coloring of the Menu Tabs on the Display.

PERFORM	MIXER	PART A	CFG A	VOICE A	FX A	ARP A	DRUM	CLIP	MIDI	SETUP
PERFORM	MIXER	PART B	CFG B	VOICE B	FX B	ARP B	DRUM	CLIP	MIDI	SETUP
PERFORM	MIXER	PART C	CFG C	VOICE C	FX C	ARP C	DRUM	CLIP	MIDI	SETUP
PERFORM	MIXER	PART D	CFG D	VOICE D	FX D	ARP D	DRUM	CLIP	MIDI	SETUP



Since your Vibes MD850 enables you to play four different sounds individually, it requires also to load four different Presets to determine which sound is played and a MIDI configuration to determine which PART is played by the current input Device.
Refer to chapter *Loading a Preset* for further information.

Macro Section

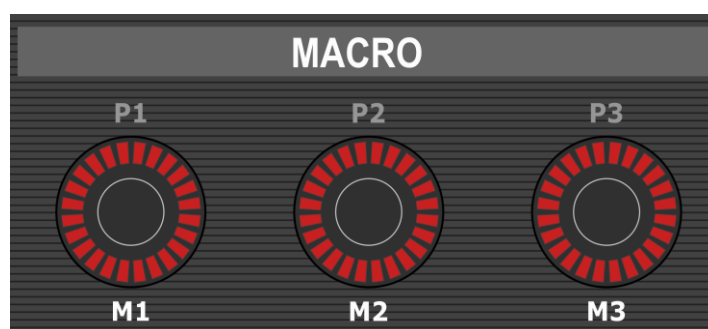

The three RGB LED Macro Knobs display and allow to modify the Macro Values of the currently selected Parts. Those Macro Values can be used to modulate various Parameters by mapping them within the Modulation Matrix of the selected Part (see *MOD (MODULATION – MATRIX)* for more details). The color of the LEDs indicates the currently selected Part.

Filter Section

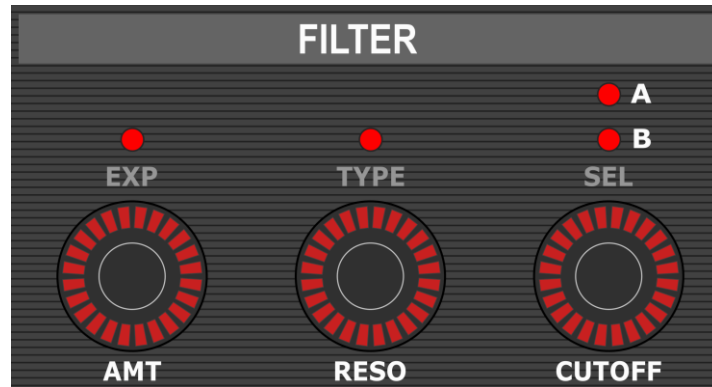

The three RGB LED Filter Knobs display and allow to modify the Filter Parameters Amount, Resonance and Cutoff of the currently selected Part. The color of the LEDs indicates the currently selected Part.

The Exponential LED indicates, if the Amount is modified in linear (Off) or exponential (On) Mode.

The Type LED indicates if the Filter is in Bypass Mode (Off) or if there is a Filter Type selected (On).

The Filter A / Filter B LEDs indicate which Filter is currently modified and displayed on the LED Encoders. Pressing the Cutoff Encoder, will switch between Filter A and Filter B of the currently selected Part.

Voice Navigation Section



The Voice Navigation Section lets you navigate to the Voice Pages of the currently active Part. The navigation is based on a two-step selection process.

Step 1: Select the functionality you want to view by pressing the according button.

If there is only one instance of this functionality, the Main Display will show the desired Function Page immediately. In case there are more than one instances of this functionality in the current Part a certain number of LEDs will light up, indicating the number of available Instances.

Step 2: Select the Instance of the functionality you want to view by pressing the button next to the instance number.

In case you don't select any instance within a few seconds, the Voice Navigation will return into its initial state and you can start with selecting the functionality again.

Synthesizer structure

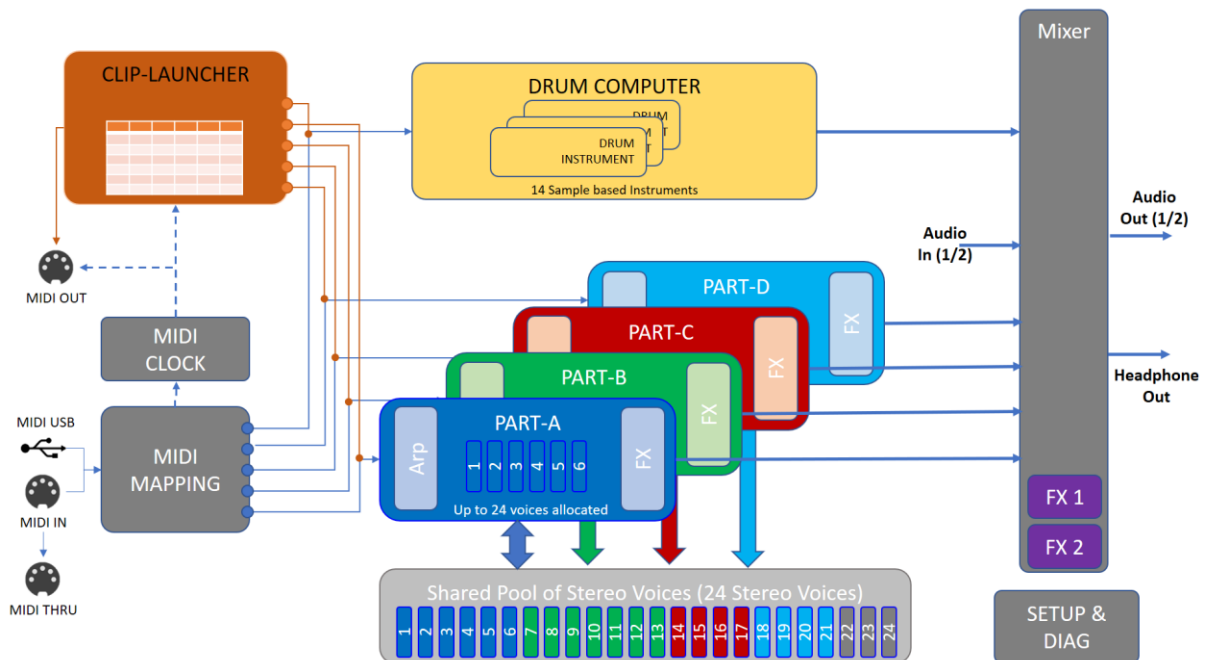

The figure gives an overview of the internal structure of the Vibes MD850 and the interrelationships between the internal components.

The synthesizer core of the Vibes MD850 is built by the 4 Parts which allow four different sounds being played simultaneously. They are all equipped with an individual arpeggiator and an individual Effect Stack (FX Stack). When an external Input device is sending MIDI Notes the MIDI Mapping will make sure the MIDI Events are routed to the right Part. To produce the sound this Part, will allocate one or multiple stereo voices out of the pool of 24 shared stereo voices. The stereo sound can be mixed through the digital Audio Mixer to the final Audio Output.

Additionally, the sample based Drum Computer can be used to add up to 14 Instruments to create a base rhythm.

The Clip Launcher can assist you in playing your Parts or the Drum Computer by stored MIDI Sequences, making your Vibes MD850 to a versatile Performance Synthesizer.

All the mentioned components are operated or set via the main menu and explained in detail in this manual at the corresponding following chapters.

Data Structure

The Vibes MD850 is equipped with an internal flash memory to store all the program and user data. The following figure gives an overview about the data relevant for the user.

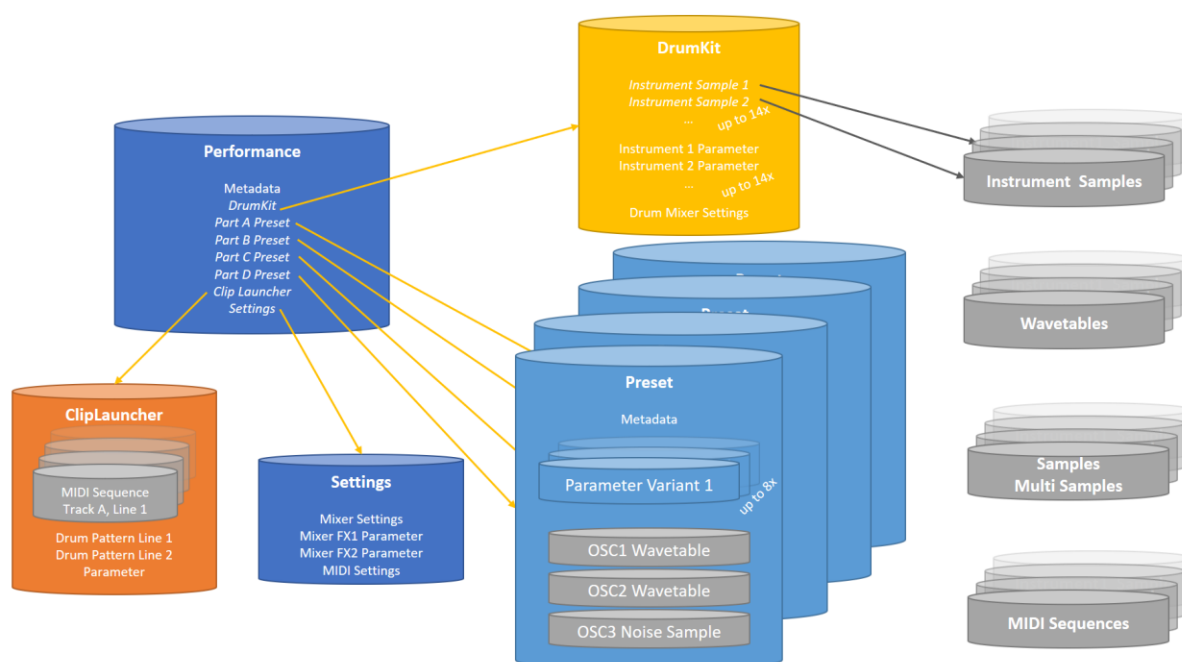

The sound relevant data is structured into multiple files to make it easier to exchange the different kind of data with other synths. Understanding the references between those files is important to understand what data needs to be saved when modifying your sounds, and what data needs to be transferred when you like to exchange sound data to other synths.

- **Preset:** A Preset contains all data for one part of your synth. This means the whole set of parameters for the Oscillators, Mix, Filter, Envelopes, LFOs, Modulation Matrix, etc. Those parameters can be stored in up to 8 Variants. Additionally, it embeds (copies at the point of saving) the selected Wavetables and Noise / Multi Samples. This makes a preset easily exchangeable since everything is embedded into the preset file.
- **Drum Kit:** A Drum Kit contains all the parameters and Mixer settings for all the 14 Drum Instruments. The Samples itself are only referenced. This means, that in case of exchanging a Drum Kit (to another Vibes MD850 for example), it is required to also exchange the used samples from that Drum Kit. On the other hand, it is very memory efficient, since samples used in multiple Drum Kits are stored only once.
- **Performances:** A Performance combines presets for each part, the Drum Kit and additional Clip Launcher Data into one Performance. The performance does not embed any of the mentioned resources, it only keeps references (by filename).
- **Clip Launcher:** The Clip Launch file keeps all the parameters and Sequences or Drum Patterns embedded in one file.
- **Settings:** Extends the Performance to keep the Mixer Settings (including the FX1 and FX2 Parameters) and the MIDI Settings.
- **Instrument Samples:** Instrument samples are wav files which will be used by the Drum Computer.

- **Wavetables:** Wavetables are stored as wav file with 2048 samples per frame times 256 frames. In case there are less than 256 frames, the table will automatically be expanded to 256 frames via linear interpolation.
- **Noise/Multisamples:** Samples for the Noise/Multisample Oscillator can either be
 - Standard Sample: Standard wav file (with optional loop points)
 - Multisample: This format embeds samples at multiple frequencies. The format is currently not publicly available and can therefore only be generated by Mayer EMI GmbH
- **MIDI Sequences:** MIDI Sequences are read as standard MIDI files

Wav File compatibility:

Whenever the wav file format is mentioned, your Vibes MD850 will accept the following file formats:

- MIME Type Format audio/wav or audio/wave
- 32bit float, 16bit integer or 32bit integer PCM
- 48kHz Mono or Stereo

PERFORM (Performance)

Performances enable you to have your Vibes MD850 ready to perform with a single touch. They reference the presets of the four parts, the drum computer, clip launcher and mixer settings into one performance file which can easily be named, saved and loaded.

Loading a Performance

The Performance List displays all available performances in alphabetical order. The list can be filtered according to 3 different filter criteria (see Filter Presets).

To load a specific performance, first use the Selection Wheel for selecting the performance in the Performance List. The metadata (Author, Category, Features) of the selected performance will be shown in the Metadata Information Section. Secondly press the Selection Wheel to load the preset. A loading popup will appear to show the loading progress and the performance will be shown as active performance afterwards.

In case you don't turn the Selection Wheel for a certain time, the list will return to the currently loaded performance.

Alternatively, you can also select the Performance directly, without a preview of the metadata by scrolling through the Performance List and touching the Performance.

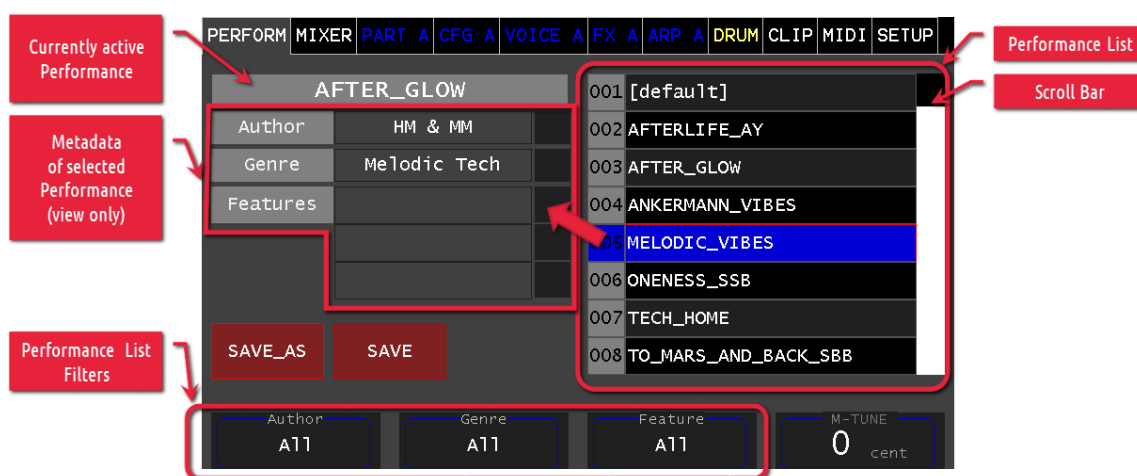

Loading the default (INIT) performance

To load the default performance (sometimes also called INIT preset) make sure the all the filters are set to All. The [default] performance shows up at the top of the list. Continue and load it like every other performance.

Filter Performances

The four Encoders allow to filter the Performance List according to 3 different filter criteria.

- **Author** allows to filter the Performance List to only show Performances created by this author.

- **Genre** allows to filter the Performance List to only show Performances assigned to a certain genre
- **Feature** allows to filter the Performance List to only show Performances which have defined the selected feature in one of their three feature fields

Selecting multiple filters will require a performance to match all filters criteria to be shown in the Performances List. The filter value **All** will disable filtering to the according criteria. Setting all filters to **All** will disable all filtering.

Saving a Performance

To save a currently loaded (and probably modified) performance, make sure you edit the Metadata Fields according to your needs. (see *Editing a Performance* for more details)

Choose between the two options depending if you want to save changes to an existing Performance or if you would like to save the copy of a Performance under a new name.

SAVE

Saves the current Performance (including the clip launcher and settings) without changing its name. The original Performance will be overwritten.

SAVE_AS

Saves a copy of the current Performance (including the clip launcher and settings) under a new name. After pressing the button, an On Screen Keyboard will ask for the new performance name. (Aborting the On Screen Keyboard will cancel the saving of the performance)



WARNING

**SAVE and SAVE_AS are saving ONLY the Performance itself.
This does not include the active Drum Kit or any Preset.
(refer to chapter *Data Structure* for more details on how
data is handled in your Vibes MD850)**

Editing a Performance

To edit the Metadata of a Performance, you have to load the Performance first (see Loading a Performance). The current Values for the different metadata fields will be shown as editable (dark background color). The Edit Icon next to each value will give you the possibility to change it via the On Screen Keyboard.

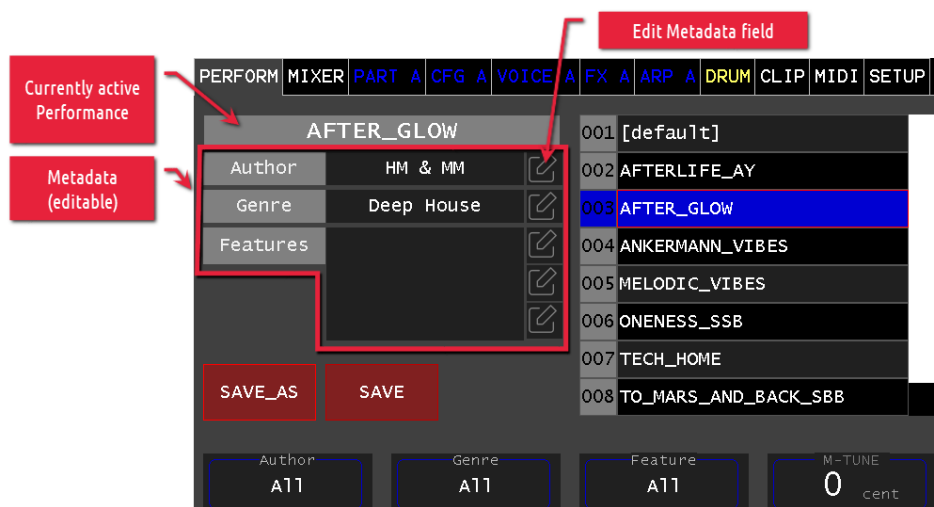

After Editing the metadata, you need to save the Performance to persist the changes (see Saving a Performance).

Managing Performances

The Performances are loaded and saved to the Vibes MD850s filesystem. You can use various methods to manage (delete, rename, import, export, move, etc.) your presets. See chapter *Export / Import* for more details.

MIXER

The digital Audio Mixer of the Vibes MD850 allows you to mix the Audio Signals of the four Parts, the 14 Drum Instruments and the external Audio-In Signal to the Master and Headphone Outputs.

Additionally, two independent Effect Stacks are embedded into the Mixer to apply Audio Effects to any of the Mixer Input Signals.

The Audio Mixer is split to 7 pages for Mixer Inputs and 1 page for Mixer Outputs.



PAGE	CHANNEL	GROUP CONTROL	CHANNEL TYPE	REMARKS
PARTS	Part-A		Input Stereo Channel	
	Part-B		Input Stereo Channel	
	Part-C		Input Stereo Channel	
	Part-D		Input Stereo Channel	
DRUM KIT	Drum Grp		Group Control	Controls all Drum Instruments
	Side Chain		Input Stereo Channel	Sum of all Instruments sent to Sidechain
DRUM 1	KICK	Drum Grp	Input Stereo Channel	
	SNARE 1	Drum Grp	Input Stereo Channel	
	SNARE 2	Drum Grp	Input Stereo Channel	
	CLHAT	Drum Grp	Input Stereo Channel	
DRUM 2	OPHAT	Drum Grp	Input Stereo Channel	
	RIDE	Drum Grp	Input Stereo Channel	
	CRASH	Drum Grp	Input Stereo Channel	
	TOM1	Drum Grp	Input Stereo Channel	
DRUM 3	TOM2	Drum Grp	Input Stereo Channel	
	TOM 3	Drum Grp	Input Stereo Channel	
	PRC 1	Drum Grp	Input Stereo Channel	
DRUM 4	PRC 2	Drum Grp	Input Stereo Channel	
	PRC3	Drum Grp	Input Stereo Channel	
INP-FX	MISC	Drum Grp	Input Stereo Channel	
	INPUT 1/2		Split Input Stereo Channel	
	FX1-RET		Input Stereo Channel	Return of the FX1 Output

MASTER	FX2-RET	Input Stereo Channel	Return of the FX2 Output
	OUT 1/2	Split Output Stereo Channel	Master Output
	HEADPH	Output Stereo Channel	Headphone Output

Schema

The following Figure gives an overview about the Mixer's signal paths. The mixer Input Channels are coming from top and will be mixed on the Busses to the right, resulting in the Mixer Output Channels.

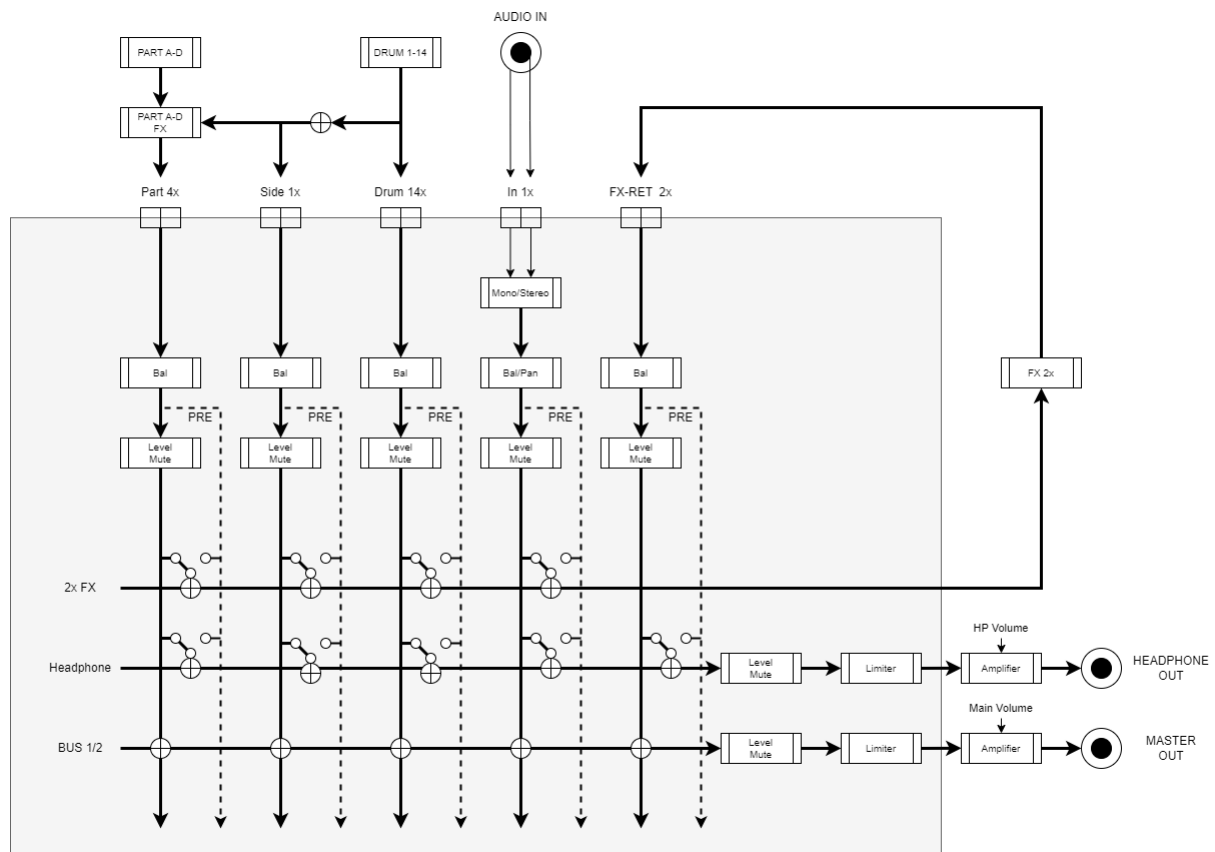

Input Stereo Channel

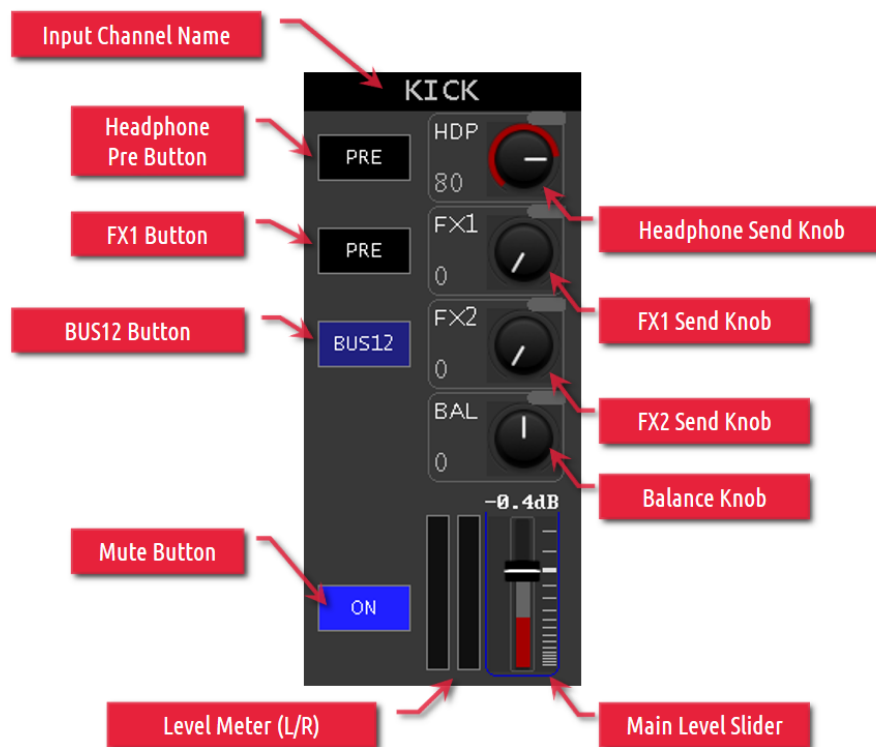

Each Mixer Stereo Channel allows the setup of the Left and the Right Stereo Mix together by a bunch of controls.

Input Channel Name

The Input Channel Name indicates where the signal which is mixed with this channel is coming from. Pressing the Name will open the most appropriate page (if exists) for this input to be configured.

Main Level Slider

The Main Level Slider allows to amplify or attenuate the incoming signal in the range of **-infinity dB** to **+6dB**. For ease of use, the Slider is scaled in a non-linear manner. The indicators next to the slider are spaced by **3dB**.

The displayed value on top of the control represents the current setting of the Slider. In case of a Group Controller is active on this channel, the red level indicator will show the final volume after the Group Controller gain is applied.

Example: Putting the channel Slider on **-0.4dB** (as shown in the figure) and having the Group Gain at **-10.0dB** will result in a total gain of **-10.4dB** when sending the signal to **Bus12**.

Headphone PRE

The Headphone PRE Button defines if the signal sent to the Headphone Bus is taken before (On) or after (Off) the Main Level amplifier. In case it is off, the Headphone Signal will change its level together with the Main Level Slider.

FX1 PRE

The FX1 PRE Button defines if the signal sent to the FX1 Bus is taken before (On) or after (Off) the Main Level amplifier. In case it is off, the FX1 Signal will change its level together with the Main Level Slider.

Headphone Send Knob

The headphone Send Knob defines the level of the signal sent on the Headphone bus. A level of 0% won't send the signal to the bus, a level of 100% will send the whole signal to the Headphone Bus.

FX1/FX2 Send Knob

The FX1/FX2 Send Knob defines the level of the signal sent on the according FX bus. A level of 0% won't send the signal to the bus, a level of 100% will send the whole signal to the bus.

Balance Knob

The Balance Knob, balances the signal between the left and right channel before it is sent to any bus. Changing the balance will therefore affect the signal on all busses.

Mute Button

The Mute Button allows to disable the signal to be sent to the busses.



Input Muted (Disabled)



Input Unmuted (Enabled)

BUS 1/2 Button

The Bus 1/2 Button defines if the current channel is sent to the Bus 1/2 (your Main Output Bus of the Vibes MD850)

Level Meter

The level meter shows the current and peak audio levels of the Left and Right channel.

Split Input Stereo Channel

Split Input Stereo Channels allow to be either handled as one Stereo Input (STEREO MODE) or two independent Mono Inputs (MONO MODE). Switch between the two different Modes by pressing the Channel Name.

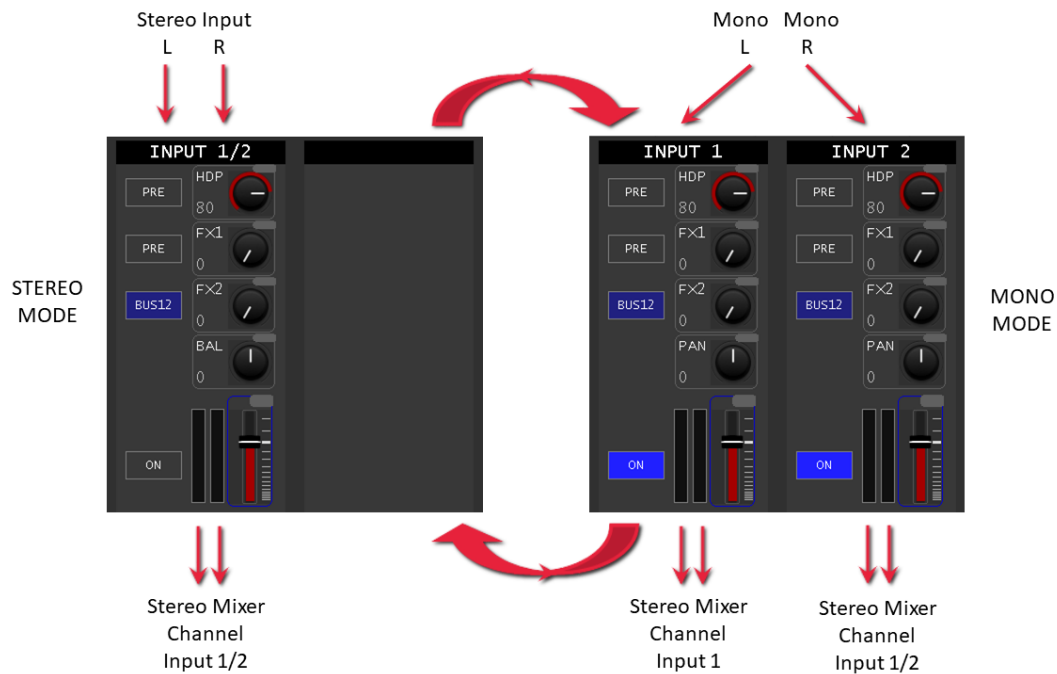

Stereo Mode handles the Input as a stereo signal and allows configuration like a standard Input Stereo Channel.

Mono Mode allows to configure all the parameters for each channel individually. The Pan Knob allows to define the stereo panorama for the two stereo outputs individually before they will be sent to the Mixer Busses as Stereo Signal. This allows to use the stereo Audio Input as two separated mono Audio Inputs for example.

Group Control

A group controller allows additional attenuation or amplification of multiple selected Input channels together with one control.

Currently the only group control is available for the Drum Inputs. It allows to control the volume of all the Drum Instruments together.

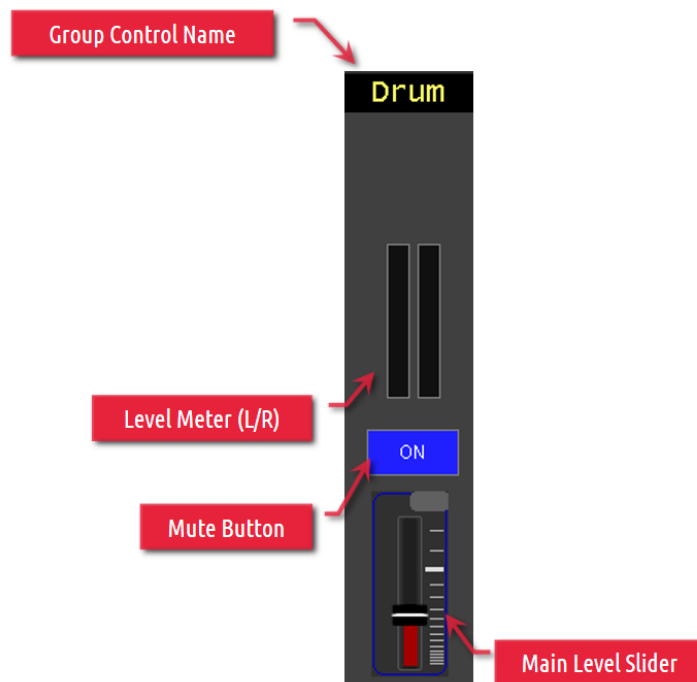

Level Meter

The level meter shows the current and peak audio levels of the sum of all Stereo Input Channels of this group (Left and Right channel).

Mute Button

The Mute Button allows to disable all Input Stereo Channels of this group.

- ON Group Muted (Disabled)
- ON Group Unmuted (Enabled)

Main Level Slider

The Main Level Slider allows to amplify or attenuate all the Input Stereo Channels of its group the range of $-\infty$ dB to +6dB. For ease of use, the Slider is scaled in a non-linear manner. The indicators next to the slider are spaced by 3dB.

The displayed value on top of the control represents the current setting of the Slider.

Example: Putting the Drum Group Control Main Level Slider on -11db (as shown in the figure) will attenuate all Drum Instruments by 11dB. The attenuation will be visible on each Input Stereo Channel by the red Level being 11dB lower than the Main Level Slider. (see *Input Stereo Channel*)

Output Stereo Channel

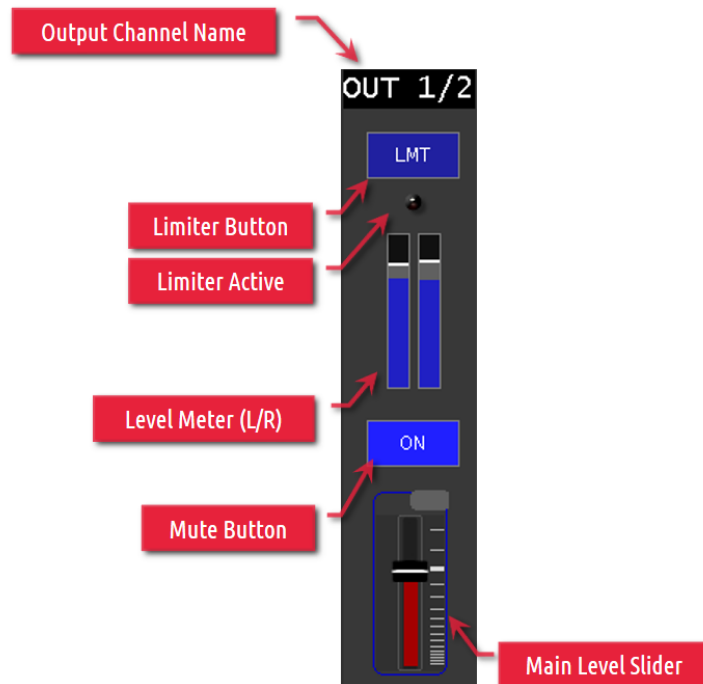

Each Mixer Output Stereo Channel allows to set the Output Level and configure a limiter on the output signal.

Output Channel Name:

The Output Channel Name indicates where the signal is put out.

Main Level Slider

The Main Level Slider allows to amplify or attenuate the outgoing Signal in the Range of $-\infty$ dB to +6dB. For ease of use, the Slider is scaled in a non-linear manner. The indicators next to the slider are spaced by 3dB.

When changed, the current gain will be displayed on top of the slider for a few seconds.

Mute Button

The Mute Button allows to disable the signal output.

- ON Output Muted (Disabled)
- ON Output Unmuted (Enabled)

Level Meter



The level meter shows the current and peak audio levels of the Left and Right channel.

Limiter Button

Activates and Deactivates the Limiter functionality. When activated the limiters compression will start at 0dB and will compress the signal until the max of +6dB. If the limiter is deactivated the signal will be clipped at +6dB.

Limiter/Clipping Active

Signals if the signal is currently limited or clipped

-  No limiting or clipping active
-  signal is getting compressed by the limiter
-  signal is getting clipped

Split Output Stereo Channel

Split Output Stereo Channels allow the output to be handled as one Stereo Output (STEREO MODE) or two independent Mono Outputs (MONO MODE). Switch between the two different Modes by pressing the Channel Name.

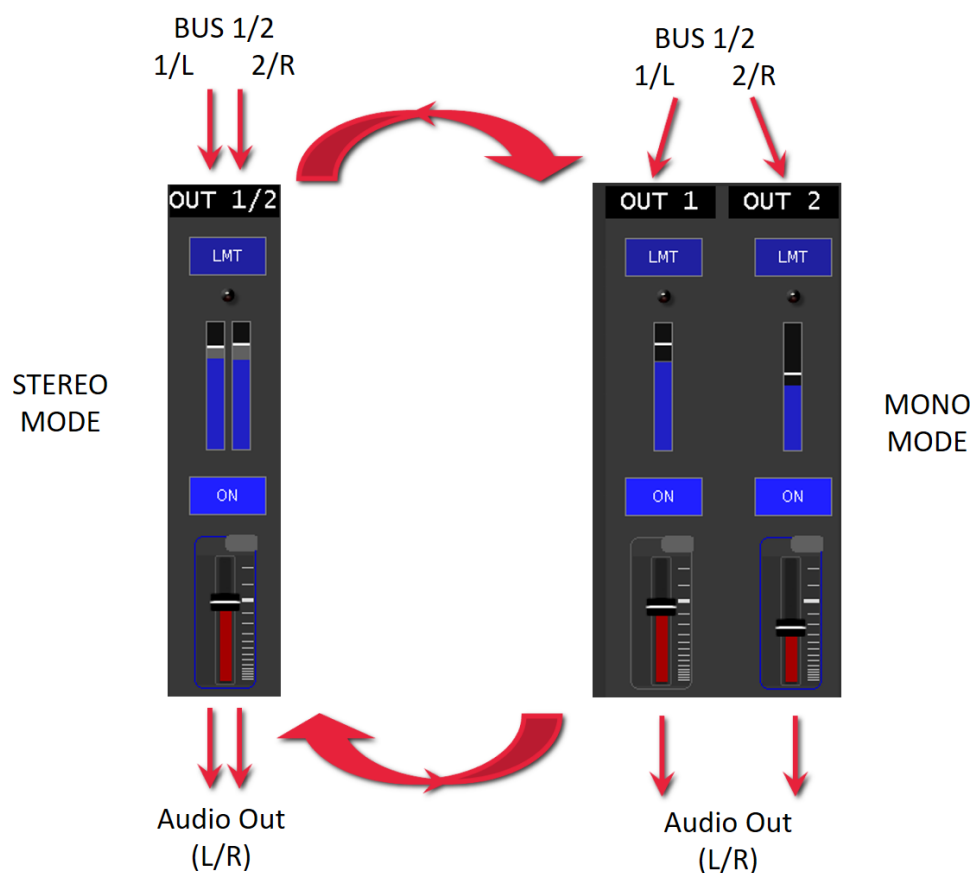

Stereo Mode handles the Output as a stereo signal and allows configuration like the limiter, the level and the mute for the whole stereo pair together.

Mono Mode allows to configure all the parameters for each channel individually. This allows the use of the Bus 1/2 for two different Drum Instruments for example.

FX 1,2 Effect Channel

Additional to the mixing functionality the Mixer has also two Effect Stacks (FX1, FX2) embedded.

These two channels will get their Inputs from the FX1, FX2 Bus and feed their outputs back into the Mixer again. Each Input Stereo Channel can send to those Busses – see FX1/FX2 Send Knob in *Input Stereo Channel*.

This for example, allows to apply effects also to Drum Instruments or the Audio-In Channel.

Since FX1 and FX2 cannot send their outputs to their own busses, they won't have any FX Send Knobs.

To configure the Effect Stack, touch the Effect Name on the according Input Channel.

Voice structure

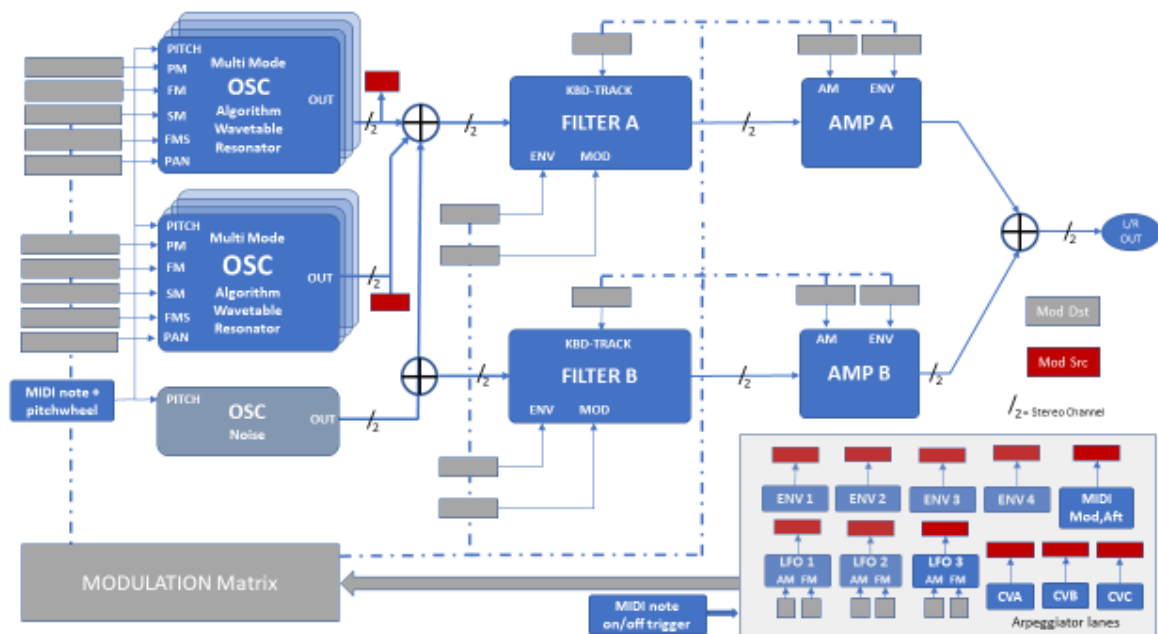

The voice (synthesizer voice) with its sections (in the analog world modules) is responsible for the sound generation in the Vibes MD850.

The sonic character is largely determined by these sections, their capabilities, structure and modulation sources and destinations. The audio path is fixed and fully stereo. The stereo path gives the Vibes MD850 its vivid spatial sound texture.

Extended features

The structure of the voices can be described as a common subtractive analog synthesizer structure. Beyond that there are some (partly digital) components extending the functionality.

On the one hand there are two parallel filter paths with filter + amplifier. These are supplied by the mixer. The mixer also allows to selectively determine through which of the two filter paths the oscillators 1, 2 and noise are to be fed. Especially with the possibilities of the wavetable or algorithm oscillators, the sound design can already be very complex by using these oscillators in conjunction with the multimode filters.

On the other hand, there are plenty of modulation sources. Together with the two filter paths and the extensive modulation possibilities of the oscillators, these allow the greatest possible movement (motion) in the sound.

Voice- shutdown

The Vibes MD850 has a total polyphony of 24 stereo voices (synthesizer voices). In the unlikely case, when very complex sounds are loaded through a preset and the demand on the computing power is too high, the Vibes MD850 automatically switches off stereo voices. On the one hand, this makes very complex presets possible, but on the other hand it leads to a loss of voices.

This procedure enables stable signal processing.



Loading a new preset enables all the voices again.
(Under the precondition that enough processing power is
available all the voices will be used again)

PART A (B, C, D)

This page allows to load and save the Preset and their Variants for the currently selected Part.

Loading a Preset

The Preset List displays all available Presets in alphabetical order. The list can be filtered according to 4 different Filter criteria (see *Filter Presets*).

To load a specific preset, first use the Selection Wheel for selection the preset in the Preset List. The metadata (Author, Category, Features) of the selected preset will be shown in the Metadata Information Section.

Secondly press the Selection Wheel to load the preset. A popup will appear to show the loading progress and the preset will be shown as currently active preset afterwards.

In case you don't turn the Selection Wheel for a certain time, the list will return to the currently loaded preset.

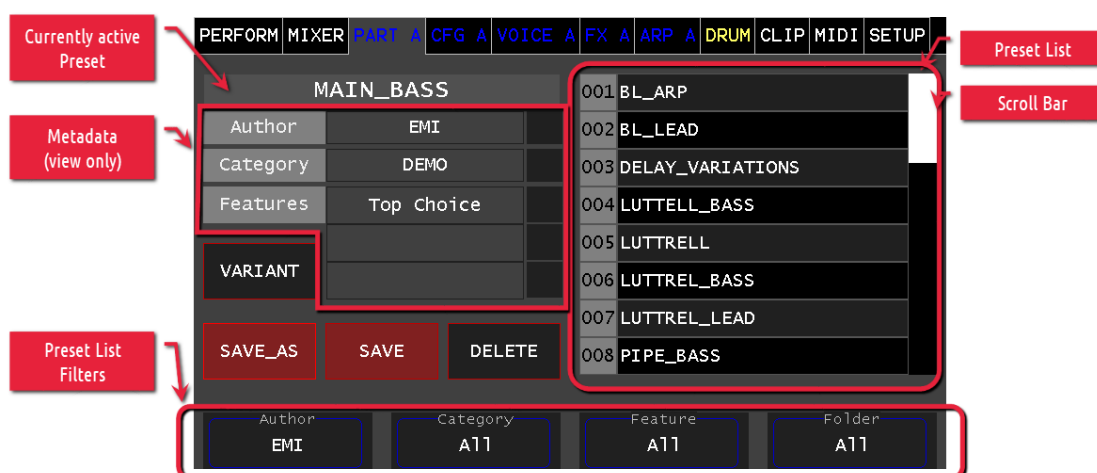

Loading the default (INIT) preset

To load the default preset (sometimes also called INIT preset) make sure the all the filters are set to All. The <default> preset shows up at the top of the list. Continue and load it like every other preset.



Setting the folder filter to **Templates** will give you a selection of templates with some predefined Parameters / Modulation Matrix Entries for the most common kind of sounds.

Filter Presets

The four Encoders allow to filter the Preset List according to 4 different filter criteria.

- **Author** allows to filter the Preset List to only show Presets created by this author.
- **Category** allows to filter the Preset List to only show Presets assigned to a certain category
- **Feature** allows to filter the Preset List to only show Presets which have defined the selected feature in one of their three feature fields
- **Folder** allows to filter the Preset List according to the Presets folder in the Vibes MD850s file system

Selecting multiple filters will require a preset to match all filters to be shown in the Preset List. The filter value **All** will disable filtering to the according criteria. Setting all filters to **All** will disable all filtering.

Saving a Preset

To save a currently loaded (and probably modified) preset, make sure you edit the metadata fields according to your needs. (see *Editing a Preset* for more details)

Choose between the following two options depending if you want to save changes to an existing Preset or if you would like to save the copy of a preset under a new name:

SAVE

Saves the current preset (its parameter, resources and metadata) without changing its name. The original preset will be overwritten.

SAVE_AS

Saves a copy of the current preset (its parameter, resources and metadata) under a new name. After pressing the button an On Screen Keyboard will ask for the new preset name. (Aborting the On Screen Keyboard will cancel the saving of the preset)

Presets saved by the user will automatically be saved into the **USER** folder in the Vibes MD850 file system. (see *Manage Presets* for more information)

When saving a preset, the following data will be saved into a preset file:

- All part specific voice settings (e.g. parameters of oscillators, filters, etc.)
- Selected wavetables will be embedded into the preset file
- Selected noise/multi samples will be embedded into the preset file
- All part specific effect settings (e.g. selected effects, parameters of the effects)
- Arpeggiator settings

Editing a Preset

To edit the metadata of a preset, you have to load the preset first (see *Loading a Preset*). The current values for the different metadata fields will be shown as editable (dark background color). The Edit icon next to each value will give you the possibility to change it via the on screen keyboard.

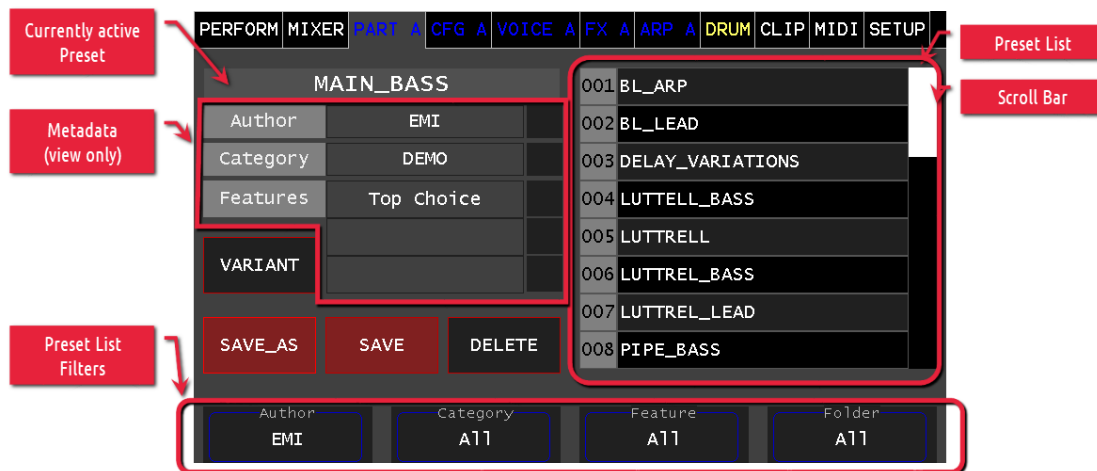

After editing the metadata, you need to save the preset to persist the changes (see *Saving a Preset*). Be aware, that this will also save other changes to the sound (parameter, etc.) you have applied between loading and saving the preset.

Deleting a Preset

To delete a preset, you have to load the preset first (see *Loading a Preset*). Touch the Delete Button and confirm the deletion by pressing the ENTER key on the Panel. The preset is deleted from your Vibes MD850 file system.

The preset will stay loaded even when it is already deleted from the file system (you can still save again to recover it). Loading a new preset will make the preset unrecoverable.

Managing Presets

The presets are loaded and saved to the Vibes MD850 filesystem. You can use various methods to manage (import, export, move, etc.) your presets. See chapter *Export / Import* for more details.

Variants

Variants allow you to quickly save and load up to 8 variants of all the sound parameters of your Vibes MD850. In case you are exploring new sounds or developing variations of your existing sounds, it helps to quickly save this variation.

Variants only store the parameters, of the current part. All variants use the same Wavetables and Noise / Multisamples stored in the preset itself.

Use the Variants Button to open the Variant page.

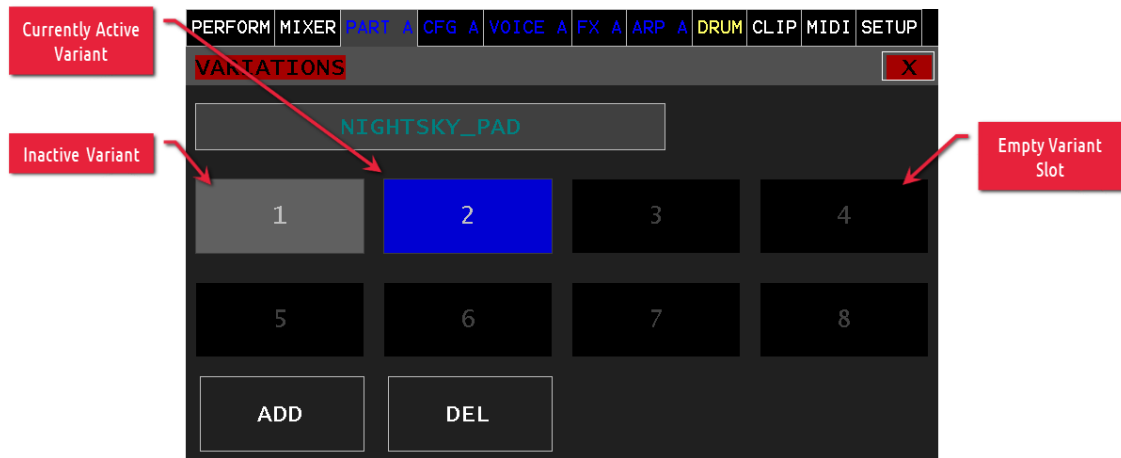

Add a Variant

Open the Variant page and touch the **Add** Button first to add your current parameters as a new Variant. Touch the Variant Slot you want to use to save the parameters as.

Remove a Variant

Touch the **Del** Button first and choose the Variant slot you want to free.

CFG A (B, C, D)

In the CFG page you can set various parameters for the currently active part.

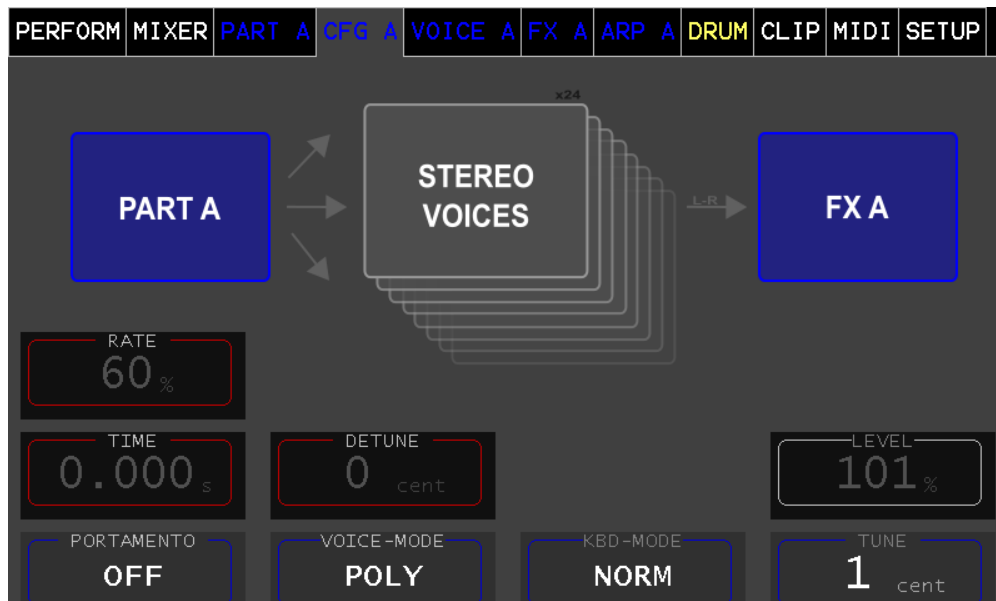

PORTAMENTO

This parameter defines the mode of the portamento (gliding of the pitch between two consecutive notes played)

- **OFF** the pitch changes immediately
- **TIME** the pitch changes in constant time (sec) from the old to the new pitch (independent of its pitch difference)
- **RATE** the pitch changes with a constant rate (%) from the old to the new pitch

TIME

In portamento mode TIME this parameter defines the duration to increase/decrease to the new notes pitch

RATE

In portamento mode RATE this parameter defines the constant rate to increase/decrease to the new notes pitch.

VOICE-MODE

The VOICE-MODE parameter defines how the voice assignment should be done.

- **MONO**: monophonic, the same voice is always assigned and emulates the behavior of a monophonic synthesizer. Only one note can be played at each point in time.
- **POLY**: polyphonic, up to 24 voices are used to play multiple notes in parallel
- **UNI2, 3, 4**: unison, up to 24 voices are used to play each note 2, 3 or 4 times detuned by the detune parameter (UNI2 uses 2 voices per note, etc.)

DETUNE

With the parameter **DETUNE** a detuning of the assigned voices in cent [+/-100] can be done (UNI2,3,4). The cent value is divided depending on how many voices are assigned.

KBD-MODE

The KBD-MODE parameter allows to set the articulation behavior in the MONO voice mode

- **NORM:** The EGs (envelope generators) are triggered with every keystroke, regardless of whether legato or staccato is played.
- **LEGATO:** If legato is played, only the pitch is taken over. The EGs are not triggered. With staccato, the EGs are triggered when each key is played.
- **GLIDE_LEGATO:** Only with a legato playing mode the GLIDE takes place. The EGs are triggered as in LEGATO mode

LEVEL

The LEVEL parameter (0-200%) allows an overall volume adjustment for the part. This allows to normalize the volume levels for a preset.

TUNE

The TUNE parameter can be used to adjust the tuning of the corresponding part in cents [+/-100] compared to the normal tuning.

VOICE A (B, C, D)

This colored main menu tab represents the **VOICE** view and serves as navigation to the individual sections. By touching the corresponding section (module), you can access its user interface. With [x] or at the panel with **ESC** you return to the VOICE view.

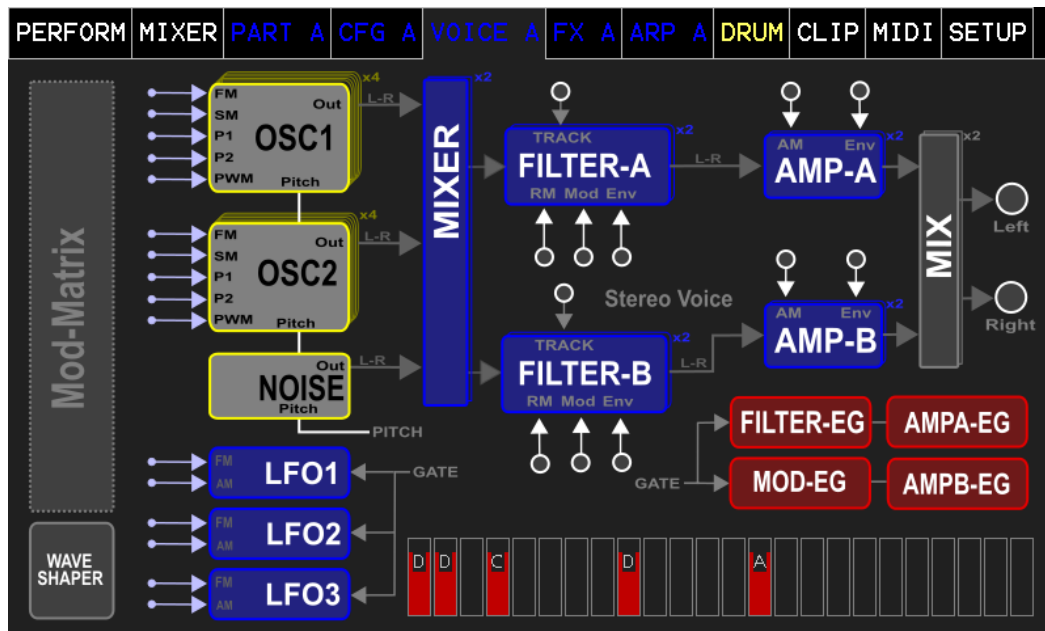

Furthermore, it shows the voice allocation. The bar height is proportional to the velocity value. By the identifier A, B, C, D the corresponding PART is displayed, by which this voice was requested. If the identifier is an (x) then this voice is deactivated.

OSCILLATOR Wavetable Mode

In wavetable mode the Oscillator uses wavetables to generate the sound. Wavetables store a number of different frames which can be scrolled through. Together with the unison stereo detuning and spectral morphing effects, you can create motion and richness into your sound.

The Oscillators OSC1 and OSC2 can be switched into this mode by pressing Encoder 1.

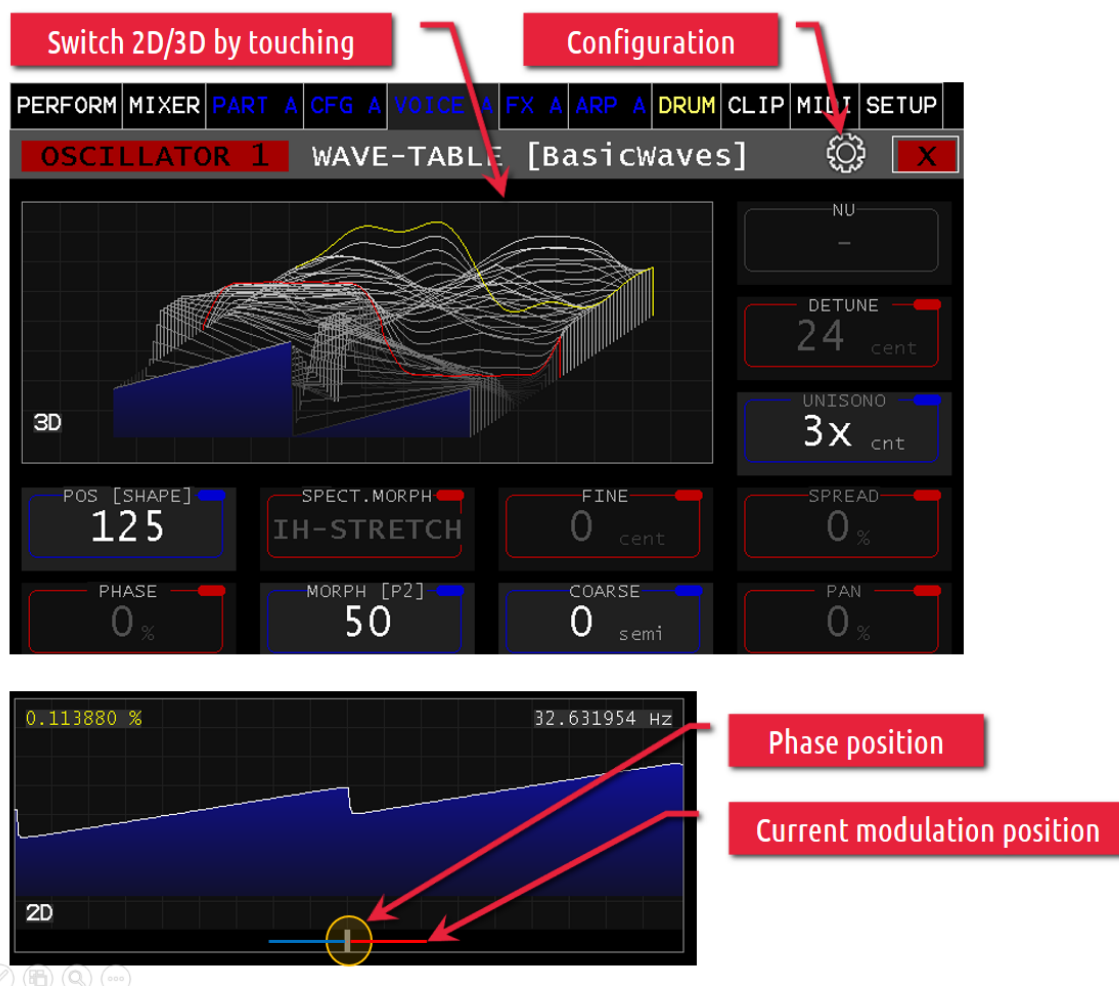

As shown in the figure, it is possible to switch between the 2D/3D view. In the 2D view, the phase position and the current modulation position (modulation) are also displayed.

Wavetable Selection

To select a wavetable, turn the selection wheel and choose your desired wavetable in the appearing popup. Confirm with pressing the Selection Wheel to load the selected wavetable.

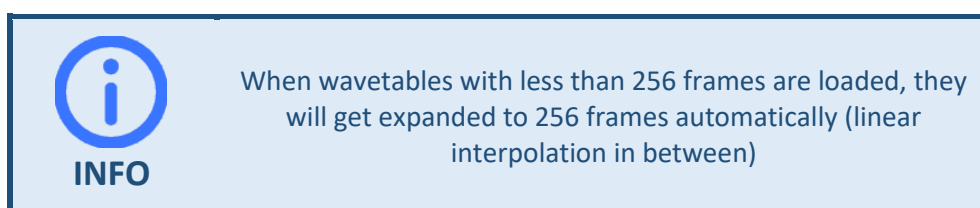



To import your own wavetables into the Vibes MD850 refer to section *Export / Import*.

POS [SHAPE]

Position (frame) in the wavetable from 0- 256.

PHASE

Phase position 0-100%

SPECT.MORPH

This parameter selects the spectral morphing algorithm used to change the frequency spectrum of the wavetable. The algorithm dependent parameter MORPH [P2] will define the level of change. Together these two parameters can create surprising and interesting textures in the sound.

- **H-SHIFT**: Shifts the whole frequency spectrum except the fundamental frequency to higher pitches.
- **IH STRETCH**: stretches (pulls the single frequencies apart or pushes them together) the frequency spectrum of the wavetable.
- **SMEAR**: smears or blurs the individual frequencies of the spectrum into each other.
- **LOW-PASS**: Low pass filtering of the frequency spectrum.
- **HP-PASS**: High pass filtering of the frequency spectrum.

MORPH [P2]

Depending on the MORPH algorithm set, the depth (H-SHIFT, IH-STRETCH, SMEAR) or the type (LOW-PASS, HIGH-PASS) is changed.

FINE

Base tone pitch fine adjustment of the oscillator in +/-50 cents.

COARSE

Base tone pitch setting in semitone steps +/-24 semitones.

DETUNE

This parameter detunes the other oscillators in UNISON mode to each other in cents. (0-200%) is the total detuning value and is divided according to the number of unison oscillators.

UNISONO

Unison mode allows to use multiple oscillators with slightly different tunings (detune) to enrich your sound. The values 2x, 3x and 4x represent the number of oscillators used (1x represents the normal sound created with only one oscillator). The negative values -2x, -3x and -4x represent again the number of oscillators used, but with the difference, that every second oscillator is shifted down by 1 octave (-1x represents again the sound created with only one oscillator).

All these additional unison oscillators are fully part of the wavetable oscillator and will not use any additional voices.

SPREAD

Adjusts the stereo width of the oscillator output signal when unison is active. At 0% the unison oscillators are fully centered, while incrementing the oscillators get spread into the stereo field.

PAN

Changes the stereo panorama of the oscillator output signal +/-100% right/left.

OSCILLATOR Algorithm Mode

The Algorithm mode follows the typical virtual analog approach, but with the possibility not only to generate the classic waveforms (SAW, PULSE, TRI etc.), but also to generate waveforms with great variability by means of different algorithms.

The Oscillators OSC1 and OSC2 can be switched into this mode by pressing Encoder 1.

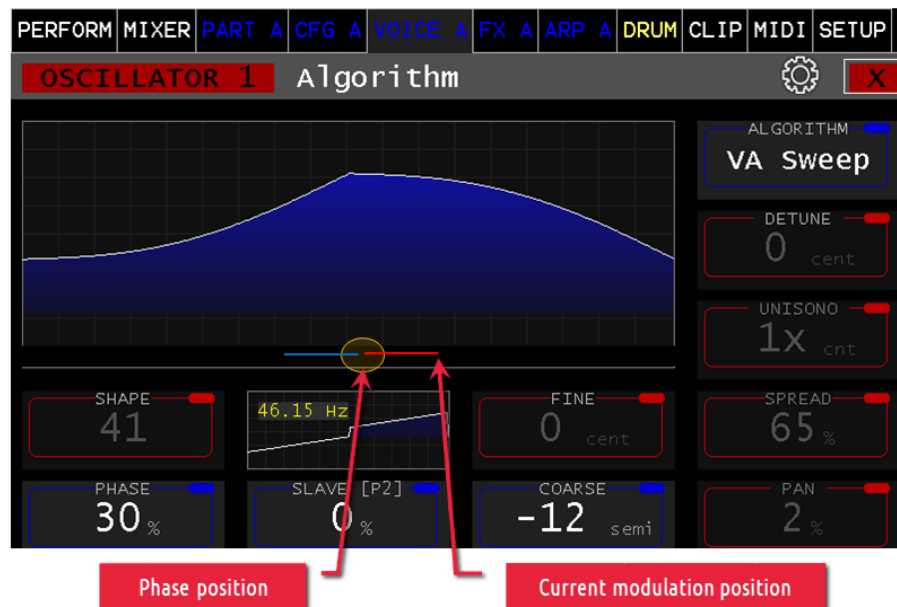

Parameters:

The parameters **PHASE**, **FINE**, **COARS**, **DETUNE**, **UNISONO**, **SPREAD** and **PAN** are identical in both modes. See description *OSCILLATOR Wavetable Mode*

SHAPE [P2]

These two parameters change the waveform depending on the selected algorithm. Parameter Range Shape 0-256, P2 0-100%

Modulations

Most of the parameters are targets for modulation in the modulation matrix. They can be switched there with various sources. Exceptions are the enumerations like ALGORITHM, UNISON and SPECT.-MORPH. These are exclusively manually adjustable.

ALGORITHM

This parameter is the selection of the algorithm for waveform generation.

- **Just SAW** Creates a classic sawtooth waveform. SHAPE & P2 have no function here.
- **VA Sweep**
Morph of: SIN->TRI (0.64), TRI->SAW (65-128), SAW->PULSE (128-192) PWM (192-256)
- **Dual PWM**
Symmetrical 2-fold pulse wave, changes the width from the center SHAPE (0-256).

- **HSync SAW**
2-fold sawtooth wave, SHAPE multiplies period SHAPE (0-256) relative to oscillator fundamental frequency.
- **PWM**
Classic pulse width change 50-95% SHAPE (0-256)
- **Formant SIN**
Formant sine: SHAPE (0.256) changes the carrier signal period, P2 (0-100%) changes the modulation period relative to the oscillator fundamental frequency
- **PD SIN**
Phase Distortion (PD): Exponential distortion of the phase of a sine wave, SHAPE (0-256) defines the degree of distortion.
- **Fract PWM**
Fractal pulse width change, proportionally multiplies the PULSE only in the positive pulse duration, a special type of pulse width change.

OSCILLATOR Resonator Mode

The Resonator is another alternative operating mode of the Oscillator and is a powerful sound generation tool. It ranges from plucked and bowed strings to tubular bells with a dissonant overtone structure.

The Oscillators OSC1 and OSC2 can be switched into this mode by pressing Encoder 1.

The Resonator is based on a band-pass filter bank with 64 band-pass filters which are excited by a noise impulse (exciter) for natural oscillation. The sound can be shaped in a variety of ways using different timbre modes. Changing the resonator parameters in real time leads to exciting and surprising results.

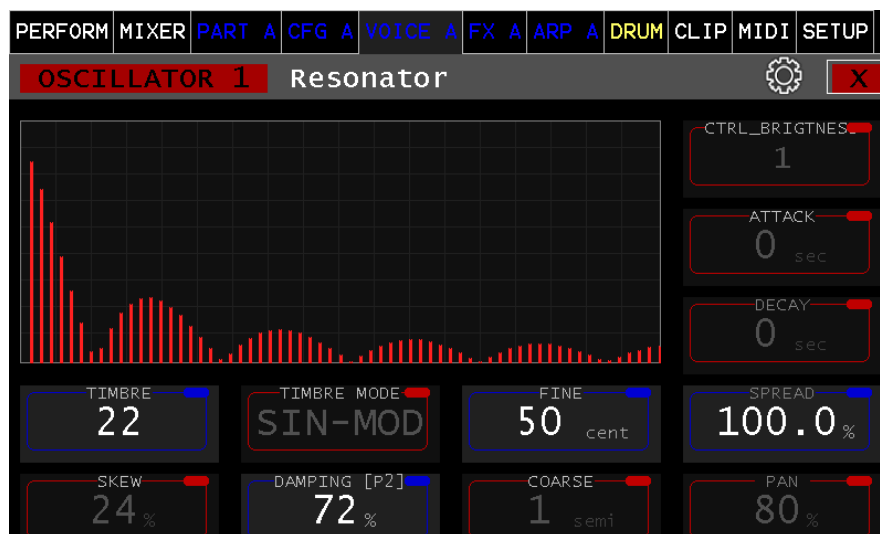

The resulting sound can be customized using the following parameters:

TIMBRE-MODE

This sets the algorithm that determines the composition of the frequency spectrum using the TIMBRE & SKEW parameter.

- **SIN-MOD**: the overtone component is superimposed via a cosine curve which can essentially be distorted by the TIMBRE.
- **SAW-SQR**: the overtone ratio is changed from a sawtooth to a square-wave-like spectrum.
- **SIN-SAW**: the overtone ratio is changed from a sine wave to a sawtooth wave-like spectrum.
- **MODULO**: more and more overtones are faded out in the direction of higher timbre values

TIMBRE

This parameter is used to define or change the basic structure of the sound depending on the TIMBRE-MODE described above. Value range [0-256]

SKEW

This parameter changes the level ratio between the fundamental tone and the partials. The way in which these changes are made is also determined by the parameter Timbre mode.

TIMBRE MODE

Lower values reduce the level of the partials more. Value range [0-100%]

DAMPING

This parameter is used to set the natural resonance behavior of the bandpasses. Value range [0-100%]

SPREAD

This parameter can be used to change the frequency spacing of the bandpasses. With a value of 0, the partial tone frequencies are harmonic and can be changed to disharmonic as the value increases. Value range [0-100%]. Press encoder 4 to change to fine resolution of the setting value (normal = 1, fine = 0.1, steps)

BRIGHTNESS

This parameter changes the overtone components of the noise impulse; higher values increase the overtone component. The sound becomes more metallic. Value range [0-100]

ATTACK

This parameter changes the attack time of the noise pulse in a similar way to the envelope generators. This can be used to generate a blowing noise or the sound of a bowed page.

DECAY

This parameter changes the decay time of the noise pulse in a similar way to the envelope generators. It is important for the simulation of the above-described blowing or bowed pages. Or is only used to adjust the sound at the attack.

FINE

Fundamental pitch Fine adjustment of the oscillator in cents. Value range [+/- 50]

COARSE

Setting the fundamental pitch in semitone steps Value range [+/- 24 Semitone]

PAN

Changes the stereo panorama of the oscillator output signal +/-100% right/left.

OSCILLATOR Configuration

Oscillators OSC1 and OSC2 can be configured additionally by pressing the  Button.

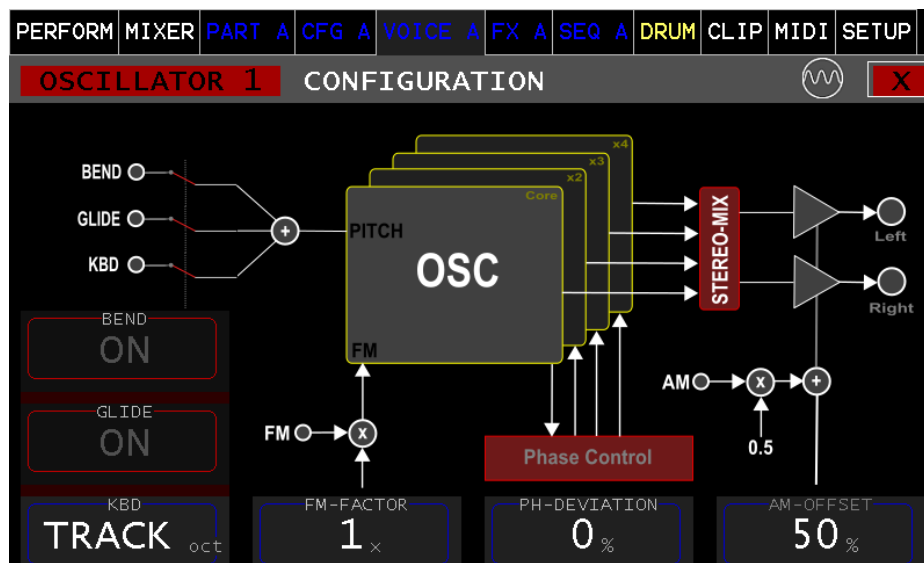

BEND

ON/OFF controls the frequency takeover by the pitch/bend wheel.

GLIDE

ON/OFF activates the Glide function for this oscillator (only valid if the Glide function for the Part is activated in the Part Configuration – see *CFG A (B, C, D)* for details)

KBD

TRACK frequency is taken from the midi note, 2-7 set a fixed octave position.

FM-FACTOR

Allows setting the multiplier for frequency modulation. (x0.1, x1, x2, x5, x10)

PH-DEVIATION

This parameter defines the phase position of the oscillators in unison mode when getting retriggered by a keystroke.

Due to the usually very small difference in frequency a phase shift between the oscillators can lead to strong variations in amplitude when summing up the signals. In worst case this can nearly lead to cancellation of the two (or more) oscillators. In case of free running oscillators, the strength of this effect is depending on the time of the keystroke. To make this effect more deterministic, this parameter allows to limit the phase deviation of the oscillators when a key is hit.

100% allows for the maximum phase deviation, which is equal to a free running oscillator. A lower value, limits the phase deviation to that value in percent (e.g. 10% will make sure, that the phases of the detuned oscillators deviate for maximum 10% when being triggered by a keystroke). 0% will synchronize the phase of the detuned oscillators with every keystroke.

AM-OFFSET

Hereby the amplitude modulation signal can be adjusted in its symmetry. In the default setting, the output level of the oscillator will be 0 with a "Unit Gain" of -1, and maximum (100%) with +1. It can thus be fully modulated with a bipolar modulation signal. If, on the other hand, the AM-OFFSET is set to 0%, the phase will be rotated with a negative modulation signal, which would correspond to a ring modulation.

OSCILLATOR Multisample Mode

Noise actually means more the ambient noise than just noise. Noise is a sample-based oscillator (Wave Files).

OSC 3 is supporting only this mode.

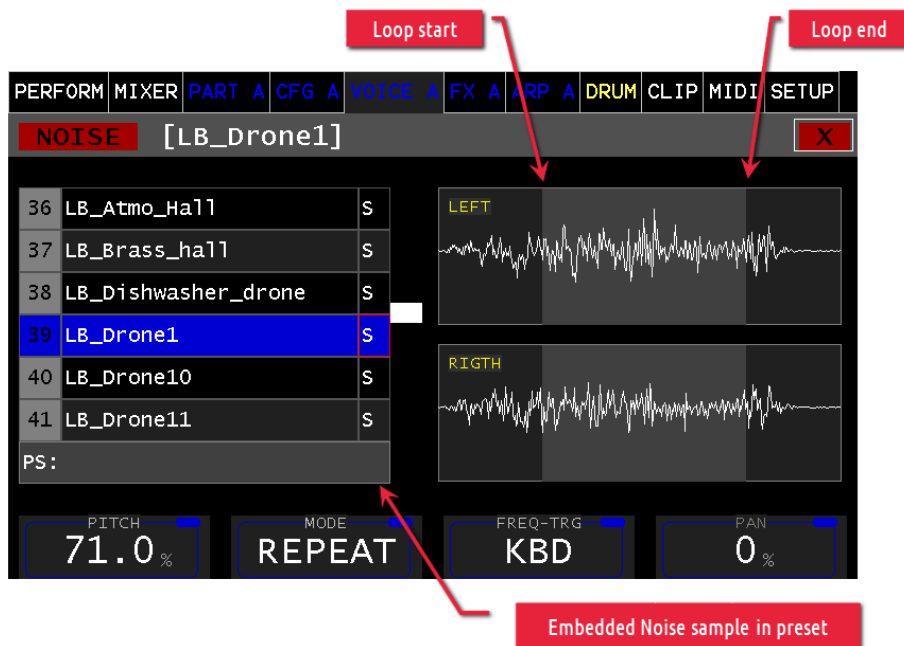

The parameter **Pitch** can be used to change the fundamental frequency of the original sample (0-200%).

The **FREQ-TRG** parameter can be used to control **KBD** tonally, if desired. In the **MAN** position the frequency is constant.

MODE

The MODE parameter determines the playback behavior

- **REPEAT:** Repeats the whole sample.
- **TRANS.:** The sample is played only once.
- **LOOPED:** If loop markers are included in the sample (area highlighted in gray), the sample is repeated between Loop Start/End. If no loop markers are present, the entire sample is repeated.

PAN

By means of this parameter it is possible to shift the left/right part (+/- 0 to 100%).

PS

This field shows the name of the sample embedded into the preset. Basically, the wave sample files are located in the file system of the Vibes MD850. When a preset is saved, the sample content is embedded into the preset. When moving samples from one Vibes MD850 to another, the sample

might not be present on the target device (but since it is embedded, the preset is still fully functional).

**WARNING**

The embedded sample shown in the PS field, might be lost when a new sample is selected from the list, and the preset is saved afterwards.

SHAPER

The Shaper (Waveshaper) allows to change the signal based on a transfer function.

This transfer function describes the output signal level (vertical Y-Axis) based on the input signal level (horizontal X-Axis).

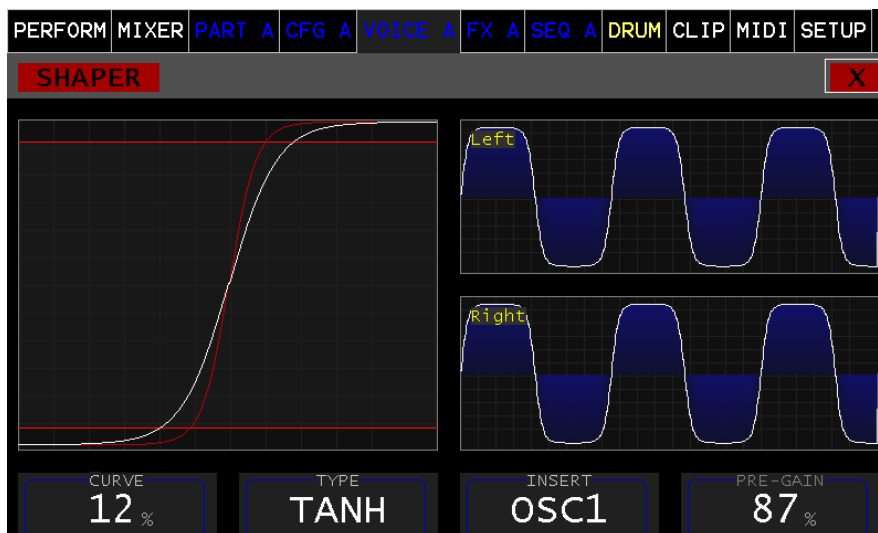

CURVE

The degree of change can be set using the CURVE parameter.

TYPE

- **TANH** (Similar to tubeamp distortion)
- **HARD** (Hard clipper that create a lot of higher harmonics)
- **ARC** (Very soft clipper)
- **SIN** (Increase the outgoing frequency, sounds like FM modulation)
- **EXP** (Soft clipper)
- **CRUSHER** (Bit crusher adds quantization steps)

INSERT

The insert of the SHAPER in the signal path can be done after OSC1 or OSC2 or the MIX of all OSC1, OSC2, NOISE (see *MIX*).

PRE-GAIN

This parameter changes the working range of the shaper.



OSC1, OSC2, NOISE generate signals with constant signal level in the case of UNISON 1

In case of using UNISON 2 or greater the signal will vary the oscillators output level. This can produce very interesting sounds with a lot of movement. Play with the oscillators DETUNE parameter

**INFO**

In general, the oscillator signals are aliasing-free. If a shaper is inserted, the output signals of the shaper can generate aliasing artifacts, which can lead to very harsh and distorted sounds

MIX

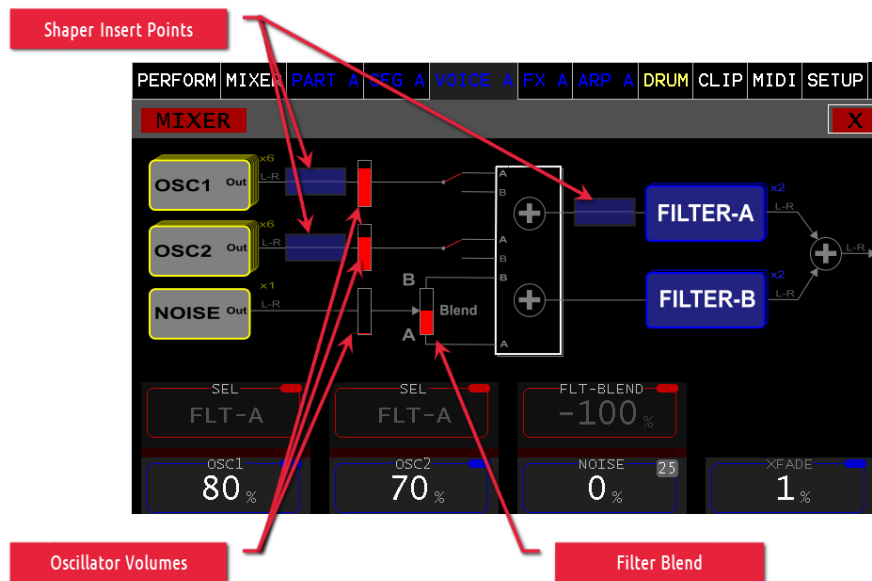

This section is the mix for the two oscillators (OSC) as well as for the noise OSC. Furthermore, the signal routing is done through which filter A, B path the signal is routed.

The oscillator levels are visualized with the bar graphs. The routing switches visualize the signal path.

SEL

With the two parameters SEL the signal path of the respective OSC can be defined. The SEL of the FLT-A path additionally allows a crossfade XFADE between the OSC 1,2 exclusively through filter A. (Is also available as destination in the modulation matrix).

FLT-Blend

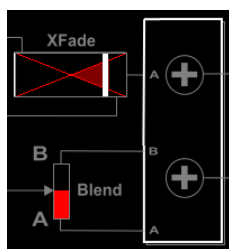

This parameter allows smooth crossfading between the two filters A, B paths.

OSC1, OSC2, NOISE

These parameters set the signal volume of the corresponding oscillators.

FILTER A(B)

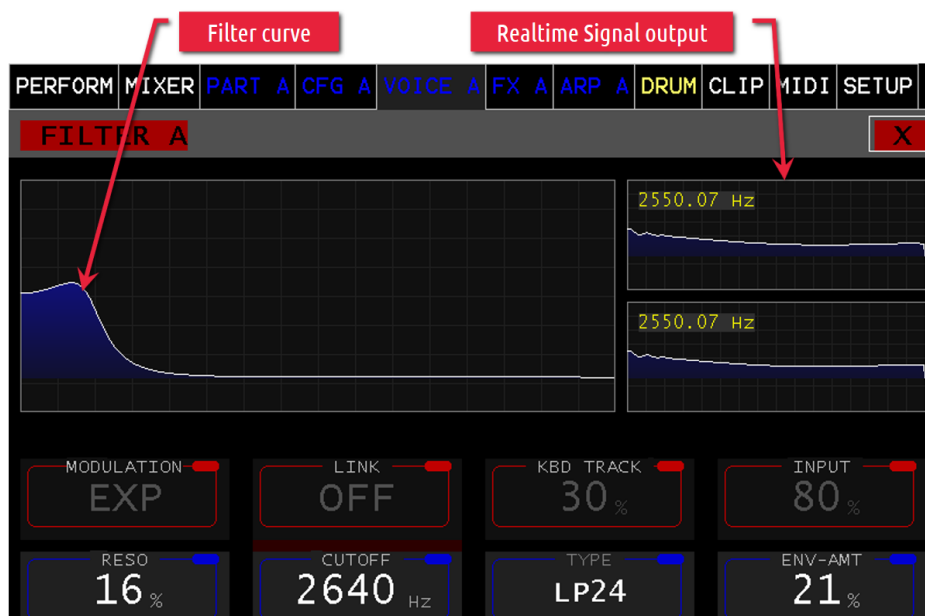

The filter section is explained here as a substitute for the FILTER B. The LINK function is only available for FILTER A. Both the FILTER A and the FILTER B are designed in stereo.

The filter curve visualizes the frequency response of the filter depending on the settings like **CUTOFF**, **RESO**, **TYPE**. The real-time display (oscilloscope) visualizes the signal output of the filter for right/left respectively.

INPUT

This parameter allows attenuating the input signal into the FILTER. (0-100%)

CUTOFF

This parameter sets the cutoff frequency of the filter. (50Hz - 17200Hz) Short press of the Encoder knob toggles between fine and coarse frequency setting.

RESO

The Resonance parameter sets the amount of feedback (0-100%). Depending on the filter type it can lead to self-resonance.

KBD-TRACK

This parameter shifts more or less the cutoff frequency depending on the set value (0-100%), depending on the played note pitch.

ENV-AMT

This parameter sets the amount of cutoff shift by the ENVELOPE signal (0-100%).

LINK

If the LINK is activated, the cutoff frequency of FILTER B is set to the same value as FILTER A. All other parameters of FILTER B remain individual.

TYPE

The filter type or filter model can be set with this parameter. The following filter types are available for selection:

- **LP24:** Stereo Butterworth low pass Filter 24dB
- **MG LD12:** Moog-style Transistor Ladder low pass 12dB
- **MG LD24:** Moog-style Transistor Ladder low pass 24dB
- **MG_VCF_LP:** Moog-style VCF low pass 12dB
- **MG_VCF_BP:** Moog-style VCF band pass 12dB
- **MG_VCF_HP:** Moog-style VCF high pass 12dB
- **SEM_LP12:** Curtis-Style low pass 12dB
- **SEM_BP12:** Curtis-Style band pass 12dB
- **SEM_HP12:** Curtis-Style high pass 12dB
- **SEM_NS12:** Curtis-Style notch 12dB
- **KG35_LP:** legendary Korg 35 (MS20)-style Filter Lowpass 12db

LFO 1(2,3)

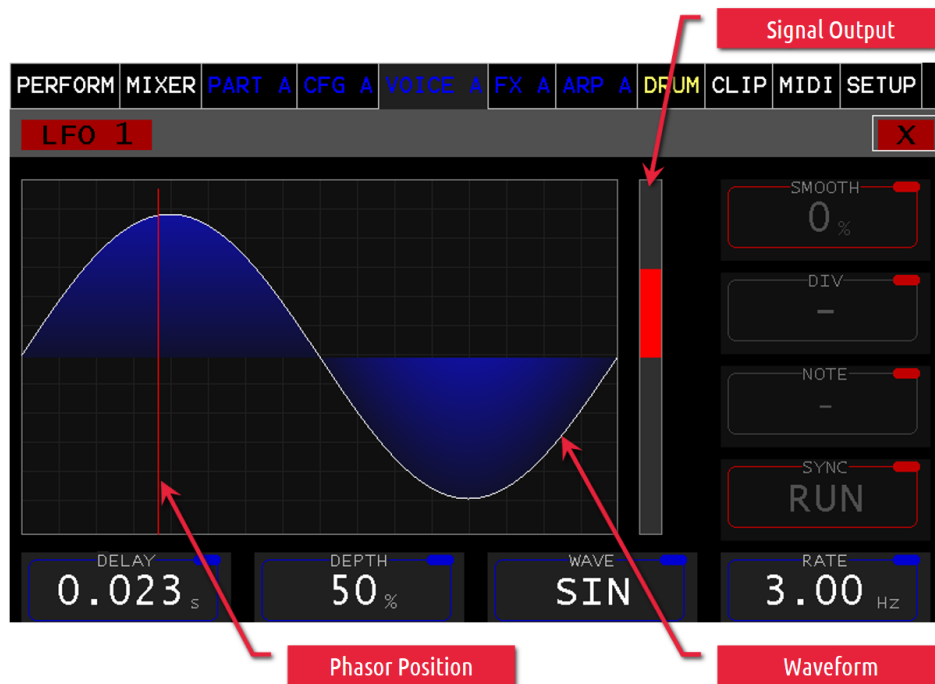

The LFO (Low Frequency Oscillator) is an indispensable helper in the matter of modulation. The 3x LFOs are explained on the basis of LFO 1. They are completely identical in operation. It should only be noted that LFO 3 is calculated only 375 times per second. It should therefore be used for really slow modulations. On the other hand, the LFO 1, 2 are calculated in the audio rate, 48000 times per second.

DELAY

This parameter allows to delay the LFO output signal (0.008s - 45s).

DEPTH

The signal depth of the output signal (0-100%).

RATE

In SYNC: RUN, KBD mode this VALUE defines the frequency in HZ (0.14Hz - 217.4Hz)

SYNC

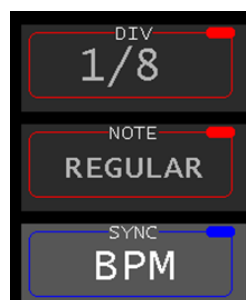

The SYNC parameter defines the operating mode or synchronization. The following operating modes are available:

- **RUN**: Continuous generation of the output signal
- **KBD**: With each new note played, the phase is reset.
- **BPM**: Is in phase with the song position and BPM (Beat per Minute), depending on the settings of **DIV, NOTE**
- **K&B**: Synchronous like BPM, with new stop the phase is reset

NOTE

Sets the factor how many LFO periods per synchronous clock:

- Triplet 3x
- Regular 2x
- Dotted 1x
- *Mod* Factor is controlled by modulation (0-32% Dotted, 33-66% Regular, 67-100% Triplet)

DIV

Sets beats (quarter note) per synchronous measure:

1=4 QN, $\frac{1}{2}$ =2 QN, $\frac{1}{4}$ =1 QN, $\frac{1}{8}$ = $\frac{1}{2}$ QN, $\frac{1}{16}$ = $\frac{1}{4}$ QN, $\frac{1}{32}$ = $\frac{1}{8}$ QN

WAVE

Allows to select the LFO waveforms. This goes from classic waveforms to more complex waveforms:

SIN

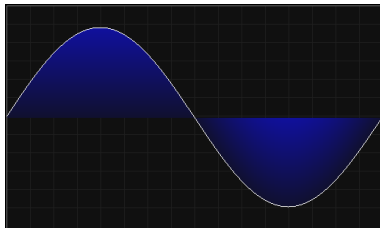

TRI

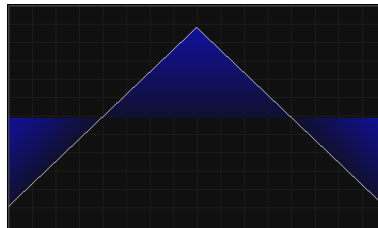

RMP_UP

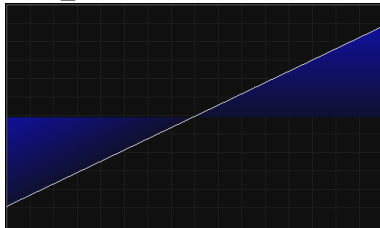

RMP_DW

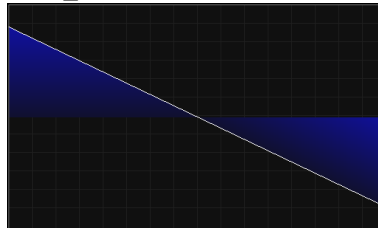

PLS_DW

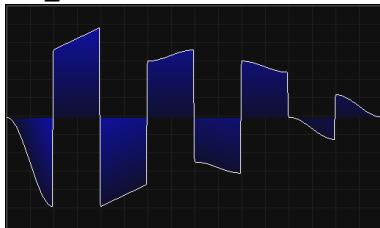

PLS_DW2

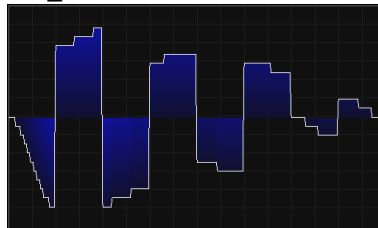

PLS_DW3

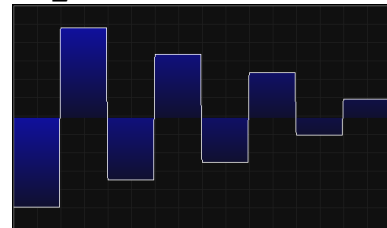

PLS_HL



PLS_LD



RAND



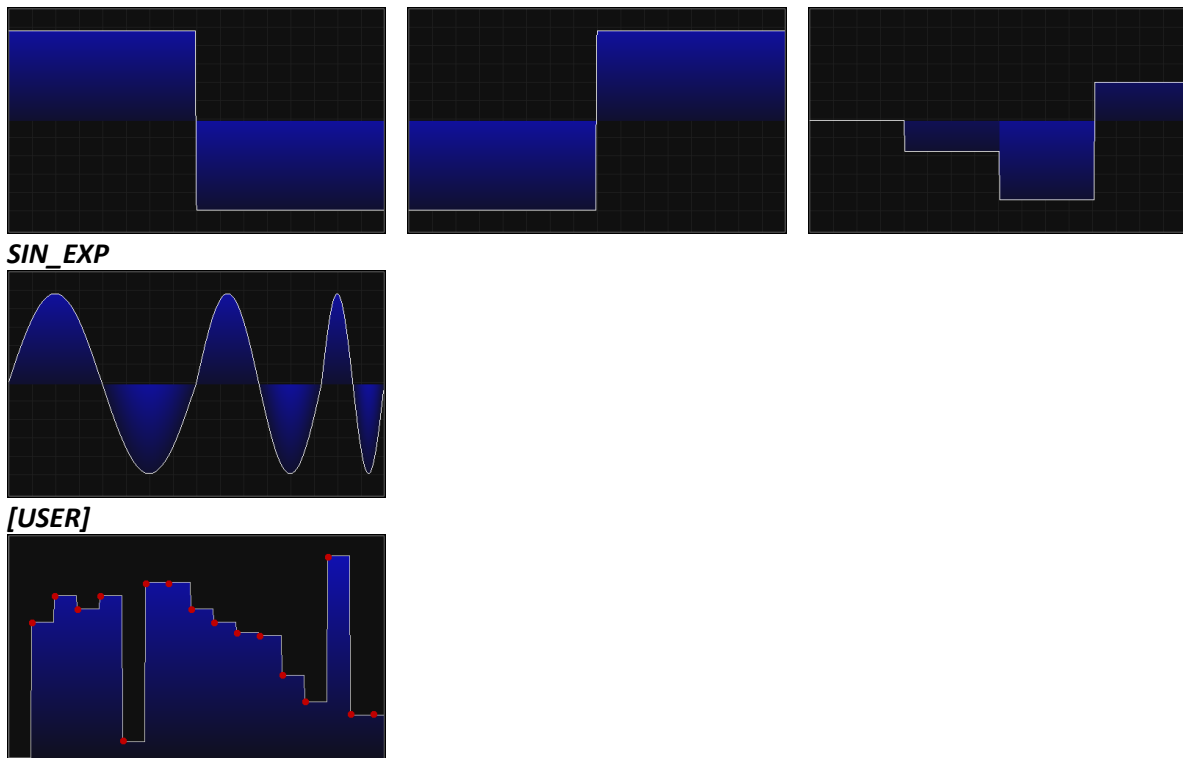

User defined LFO

This last waveform [USER] can be defined/drawn by the user. This is done by the 16 points which are internally interpolated to a complete high resolution "Wavetable". These points can be moved vertically directly on the touch display and smoothed with the help of the **SMOOTH** parameter (0-100%). In the case of not smooth, this is like a step LFO, even the **SMOOTH** parameter is increased the waveform looks more like drawn.

The screenshot shows the **LFO 1** control interface. At the top, a menu bar includes **PERFORM**, **MIXER**, **PART A**, **CFG A**, **VOICE A**, **FX A**, **SEQ A**, **DRUM**, **CLIP**, **MIDI**, and **SETUP**. The **LFO 1** section features a central waveform display with 16 red dots representing the wavetable points. A yellow circle highlights one point, with a red arrow pointing to it from a **Drag Vertikal** annotation. To the right, a **SMOOTH** parameter is set to **0 %**, with a red arrow pointing to it from a **Smooth** annotation. Below the waveform, there are four control boxes: **DELAY** (0.000 s), **DEPTH** (50 %), **WAVE** ([USER]), and **RATE** (3.00 Hz). A vertical slider is also visible on the right side of the waveform display.

ENV (Envelope Generators)

The four envelope generators (EG) are explained as representative for all of them, since they are completely identical.

The names have turned out differently for reasons of space, here a short reference.

NR	Modulations-Matrix	Default Routing
1	EG-A	Amplifier A
2	EG-B	Amplifier B
3	EG-FLT	Filter A,B
4	EG-MOD	---

The curve view shows the amplitude progression over time, based on the current settings. The realtime cursor visualizes the progression of every trigger while the envelope generator state for the last trigger is shown as state.

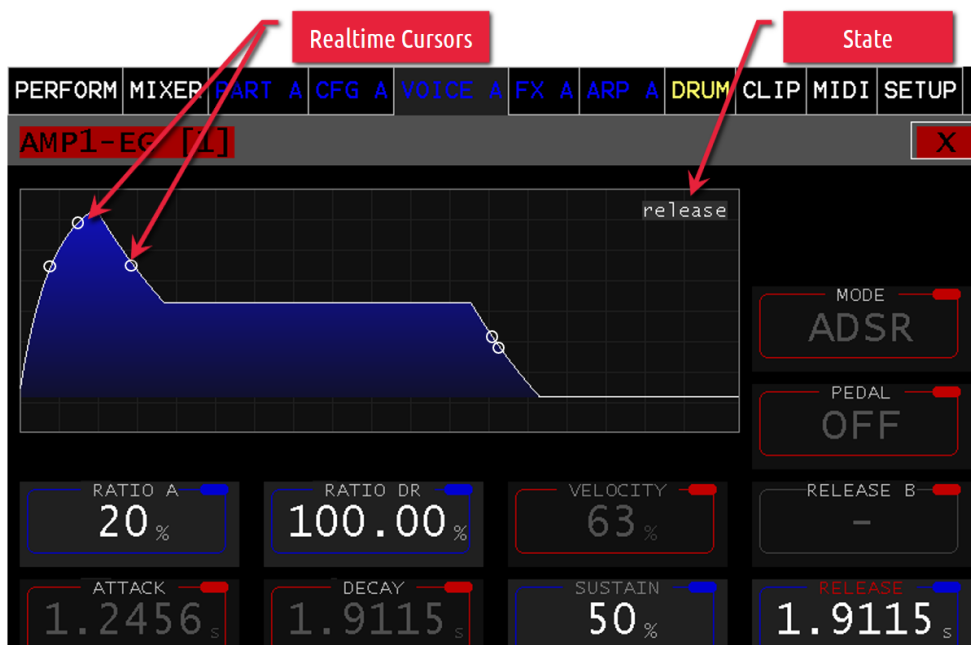

ATTACK

This parameter sets the rise time (0.5ms - 32s).

DECAY

This parameter sets the fall time (0.5ms -32s) to sustain.

SUSTAIN

This parameter sets the hold value (0-100%) which is valid until the key is released again.

RELEASE

This parameter sets the fall time (0.5ms -32s) from the hold value (SUSTAIN) to the value 0.

RATIO A

With this parameter you can change the attack curve from exponential to almost linear (0- 100%).

RATIO DR

With this parameter you can adjust the two decay curves (Decay, Release) from exponential to almost linear (0- 100%).

VELOCITY

This parameter allows to make the envelope output signal dependent on the velocity (0-100%). Where the value 0 does not consider velocity and 100% affects the full velocity of the output.

MODE

This selection determines the operating mode of the EG. These are the following:

- **ADSR**: All 4 Phases (Standard Mode)
- **AR**: Attack & Release
- **AD**: Attack & Decay
- **AD_LOOP** similar to AD, repeats independently until released

PEDAL

If a sustain/hold pedal is connected, this parameter is set to "OFF" then everything works as described before.

SUSTAIN:

Selects between two release times. Release when the pedal is not pressed, Release B when the pedal is pressed.

HOLD:

If the pedal is pressed and then a key is released, the EG remains in the Sustain phase until the pedal is released. Then it changes to the release phase.

If these settings in the EG's (AMP-EG, FILTER-EG, MOD-EG) are set differently, interesting effects can arise.

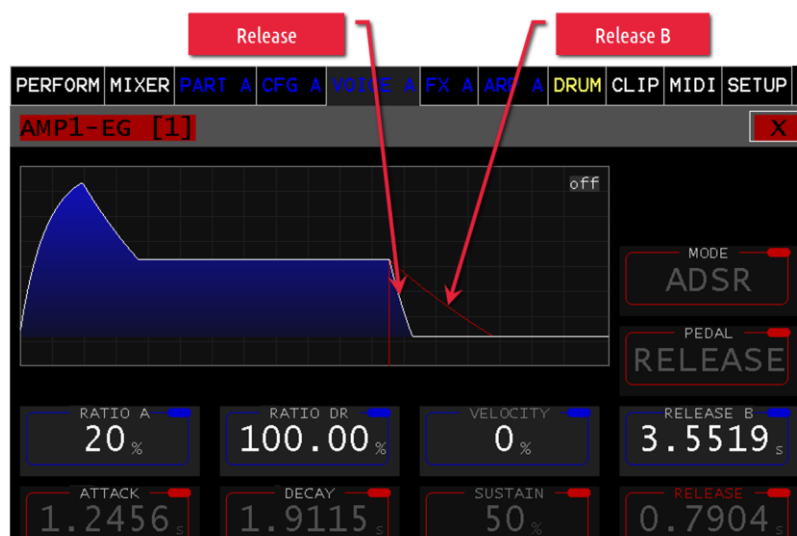

MOD (MODULATION – MATRIX)

The modulation matrix allows the connection of signal sources with signal destinations. This is displayed in a list form.

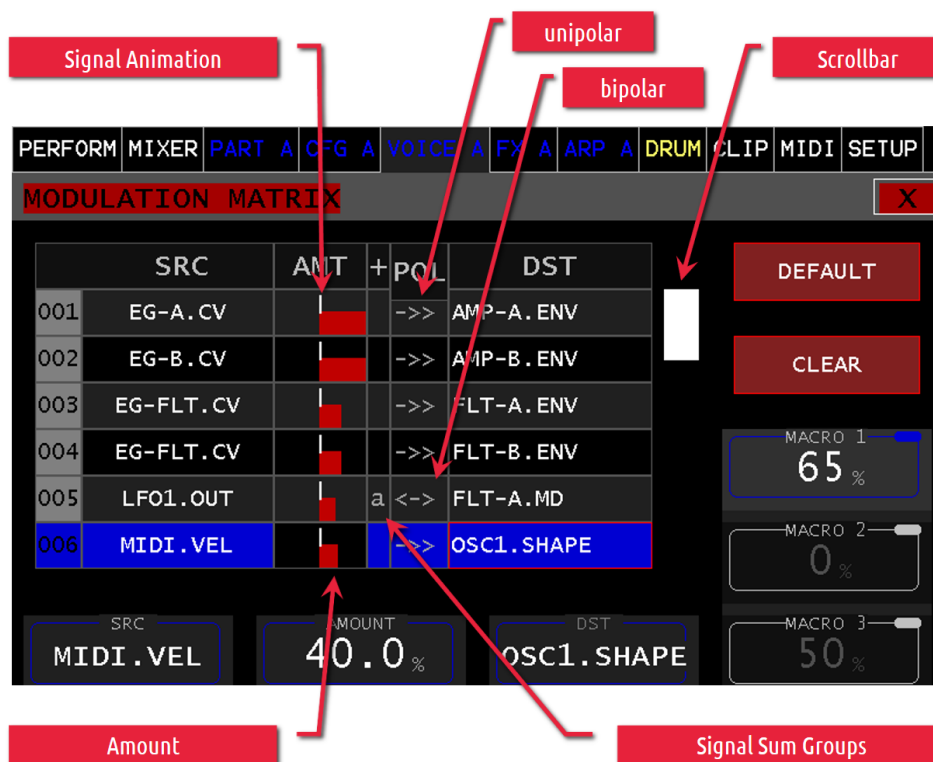

The Selection Wheel can be used to scroll through the List of Modulation entries. When an entry is selected, the encoders allow the modification of the entry parameters.

The signal animation shows the level from the perspective of the modulation target. The selected polarity behavior is also from the perspective of the modulation destination and is independent of the signal source. Example: if an LFO1.out (bipolar) is mapped to an AMP.AM signal and the signal is set to unipolar, it is shifted and the level is halved so that a signal range of -100% to + 100% becomes 0-100%

DEFAULT

This button resets the matrix to the four basic entries.

CLEAR

Deletes a selected entry.

MACRO 1, 2, 3

This Labels represent the value of the Macro Encoders on the front panel (see *Macro Section*). They can be used as Modulation Source in the modulation matrix like any other signal.

SRC

This parameter is used to select the source (SOURCE) of a selected entry.

AMOUNT

By means of this parameter the signal of the source, of a selected entry, can be attenuated or inverted. (+-0-100%) This is indicated by the bar in red/blue (blue inverted).

DST

By means of this parameter the signal destination (DESTINATION) of a selected entry can be selected.

Signal Summing

If different signal sources are assigned to the same signal destination, these signals are added up. They are automatically grouped (signal Sum. Group) and displayed with lowercase letters in the "+" column (a-z). This gives a good overview of these multiple assignments.

Signal Animation

The current target signal is displayed in the AMT column above the Amount bar. This display is in real time. Fast signals cannot be visualized completely.

SOURCE References:

1	EG-A.CV	AMP Envelope Generator A out	0 to 100%
2	EG-B.CV	AMP Envelope Generator B out	0 to 100%
3	EG-FLT.CV	FILTER Envelope Generator out	0 to 100%
4	EG-MOD.CV	MOD Envelope Generator out	0 to 100%
5	LFO1.OUT	LFO 1 out	+ -100%
6	LFO2.OUT	LFO 2 out	+ -100%
7	LFO3.OUT	LFO 3 out (375 Hz Rate)	+ -100%
8	FLTA.OUT	FILTER A Signal out	+ -100%
9	FLTB.OUT	FILTER B Signal out	+ -100%
10	CVA	Control Voltage A (Arpeggiator)	0 to 100%
11	CVB	Control Voltage B (Arpeggiator)	0 to 100%
12	CVC	Control Voltage C (Arpeggiator)	0 to 100%
13	MIDI.VEL	MIDI Velocity (0 - 127)	0 to 100%
14	MIDI.PITCH	MIDI Pitch	+ -100%
15	MIDI.AFT	MIDI Aftertouch (0 -127)	0 to 100%
16	MIDI.MOD	MIDI Modulation Wheel (0-127)	0 to 100%
17	FIX	Signal 100%	100%
18	MIDI.#NOTE	MIDI Note (0-127)	+ -100%
19	RANDOM	Note On Random	0 to 100%
20	MACRO 1	Macro 1 Value	+ -100%
21	MACRO 2	Macro 2 Value	+ -100%
22	MACRO 3	Macro 3 Value	+ -100%

DESTINATION References:

1	OSC1.FM	Common OSC 1 Frequency Modulation	+ -100%
2	OSC1.SHAPE	Common OSC 1 Shape Modulation	0-255
3	OSC1.DTUNE	Common OSC 1 Unison detune	+ -100%
4	OSC1.PAN	Common OSC 1 Panorama	+ -100%

5	OSC1.PM	Common OSC 1 Phase Modulation	+/-100%
6	OSC1.P1	Common OSC 1 P1	+/-100%
7	WTOSC1.MPH	WaveTable OSC 1 spectral morph	+/-100%
8	ALGOSC1.P2	Algorithm OSC 1 P2	+/-100%
9	OSC2.FM	Common OSC 2 Frequency Modulation	+/-100%
10	OSC2.SHAPE	Common OSC 2 Shape Modulation	0-255
11	OSC2.DTUNE	Common OSC 2 Unison detune	+/-100%
12	OSC2.PAN	Common OSC 2 Panorama	+/-100%
13	OSC2.PM	Common OSC 2 Phase Modulation	+/-100%
14	OSC2.P1	Common OSC 2 P1	+/-100%
15	WTOSC2.MPH	WaveTable OSC 2 spectral morph	+/-100%
16	ALGOSC2.P2	Algorithm OSC 2 P2	+/-100%
17	FLT-A.MD	Filter A Modulation	+/-100%
18	FLT-A.ENV	Filter A Envelope	+/-100%
19	FLT-B.MD	Filter B Modulation	+/-100%
20	FLT-B.ENV	Filter B Envelope	+/-100%
21	AMP-A.ENV	Amplifier A Envelope	0 - 100%
22	AMP-A.AM	*Amplifier A Modulation	0 - 100%
23	AMP-B.ENV	Amplifier B Envelope	0 - 100%
24	AMP-B.AM	*Amplifier B Modulation	0 - 100%
25	LFO1.AM	LFO 1 Amplitude Modulation	+/-100%
26	LFO1.FM	LFO 1 Frequency Modulation	+/-100%
27	LFO2.AM	LFO 2 Amplitude Modulation	+/-100%
28	LFO2.FM	LFO 2 Frequency Modulation	+/-100%
29	LFO3.AM	LFO 3 Amplitude Modulation	+/-100%
30	LFO3.FM	LFO 3 Frequency Modulation	+/-100%
31	XFADE-A	Cross Fade OSC1/OSC2 to Filter A	+/-100%
32	OSC1.FMAMT	Common OSC1 FM Amount	0 – 100%
33	OSC2.FMAMT	Common OSC2 FM Amount	0 - 100%
34	OSC1.AMAMT	Common OSC1 AM Amount	0 - 100%
35	OSC2.AMAMT	Common OSC2 AM Amount	0 - 100%
36	OSC1.AM	Common OSC1 Amplitude Modulation	0 - 100%
37	OSC2.AM	Common OSC2 Amplitude Modulation	0 - 100%
38	EG-A.ATTACK	*Amplifier A Envelope attack time	+/-100%
39	SHAPER.CM	Shaper Curve Modulation	+/-100%
40	SHAPER.PGM	Shaper Pre-Gain Modulation	0-100%
41	NOISE.FM	Noise OSC Frequency Modulation (TZ)	+/-100%
42	NOISE.FMAMT	Noise OSC Frequency Modulation Amount	0 – 100%
43	EG-A.DECAY	*Amplifier A Envelope decay time	+/-100%
44	EG-B.ATTACK	*Amplifier B Envelope attack time	+/-100%
45	EG-B.DECAY	*Amplifier B Envelope decay time	+/-100%
46	EG-FLT.ATTACK	*FILTER Envelope attack time	+/-100%
47	EG-FLT.DECAY	*FILTER Envelope decay time	+/-100%
48	EG-MOD.ATTACK	*MOD Envelope attack time	+/-100%
49	EG-MOD.DECAY	*MOD Envelope decay time	+/-100%

*place holder for future version updates

FX A, B, C, D, 1, 2 (Effect)

The Vibes MD850 is equipped with 4 Part specific (one for each FX A, B, C, D) and 2 Mixer (FX 1, 2) Effect Stacks.

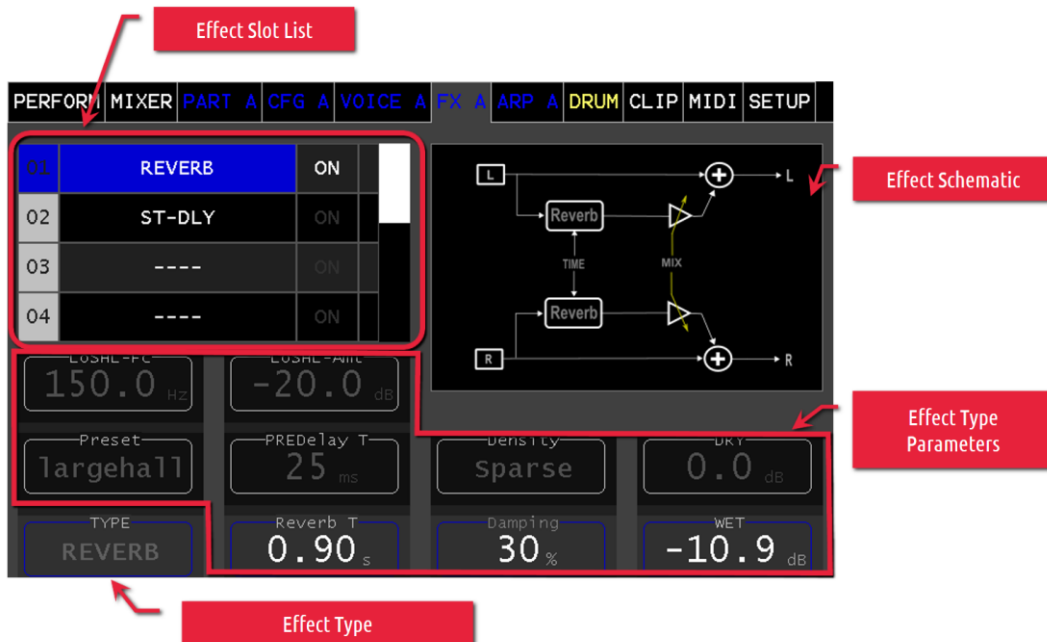

The Effect Slot List, allows up to 10 Effect being inserted in a flexible order. When enabled, the Effects will be applied in the order from top of the list first (Effect 01) to the bottom of the list last (Effect 10).

Insert Effect

To add an Effect simply select your desired slot by touching it in the Effect Slot List. Use Encoder 1 to choose the TYPE of effect you want to insert into that slot and press the Encoder 1. The effect will be added as disabled into the chosen slot.

Enable/Disable Effect

To enable or disable an Effect, simply touch the On Button of the Effect Slot.

- ON Effect Enabled
- ON Effect Disabled

Remove / Change Effect

To remove or change an Effect, simply select the Effect Slot in the Effect Slot List you want to remove/change. Use Encoder 1 to change the TYPE to --- to remove the effect or to the new Effect type you want to insert into that slot.



INFO

Each Effect type can only be inserted exclusively into one slot. This means as soon as an Effect Type is inserted into one slot, it won't appear in the TYPE list for any other slot anymore.

Effect Types:

- MOD-DLY
- PARAM-EQ
- ST-DLY
- MOOGFLT
- TUBEAMP
- REVERB
- DYNAMIC
- PHASER
- j6-chorus

ARP A (B, C, D) (Arpeggiator)

The arpeggiator allows to cycle through a series of notes, synchronized to the beat. The definition of notes is thereby generated via the keyboard.

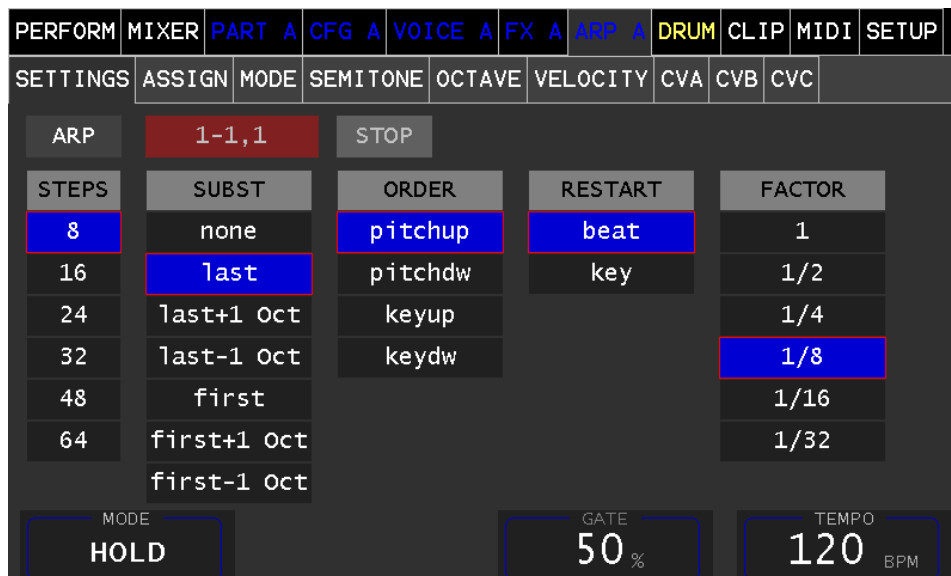

MODE

The **MODE** parameter defines the way you enter the notes to be cycled through (the so called note stack).

- **OFF** the arpeggiator is inactive
- **ON** the arpeggiator cycles step by step through all the keys of a played accord, as long as the accord is played (stops playing when the accord is released).
- **HOLD** the arpeggiator cycles step by step through all the keys of the currently played accord. As soon as the keys are released the arpeggiator will continue to cycle through the accord which was played at the last beat. (Latching at the beat)
- **LATCH** the arpeggiator cycles step by step through all the keys of the currently played accord. As soon as the keys are released the arpeggiator will continue to cycle through the last accord. (Latching happens at any time)
- **ADD** you start with playing the first key. While keeping this first key held, you can add up to 4 more keys by playing one note after the other (adding them step by step to the note stack). The note stack will be kept after releasing all keys until you play a new first key.
- **LIVE-SEQ** the arpeggiator cycles step by step through all the keys of a played accord (min two keys). After releasing the keys, the arpeggiator keeps the note stack. You can transpose (move) the note stack by pressing a single key (this note will be the base note for the arpeggio)

GATE

The **GATE** parameter sets the note on / note off time ratio.

TEMPO

The **TEMPO** parameter sets the beats per minute (BPM).

SETTINGS

This page allows to set the basic operating modes.

STEPS

Sets the number of steps until repetition

SUBST

Determines which of the keys will be played as a substitute.

- **none:** No play
- **last:** The last key played
- **last+1 Oct:** The last key played increased by 1 octave
- **last-1 Oct:** The last key played decreased by 1 octave
- **first:** The first key played
- **first+1 Oct:** The first key played increased by 1 octave
- **first-1 Oct:** The first key struck decreased by 1 octave

ORDER

Sets the order in which the struck keys are sorted (K1-K5)

- **pitchup:** Pitch in ascending order
- **pitchdw:** Pitch in descending order
- **keyup:** In the struck ascending order
- **keydw:** In the struck descending order

RESTART

Acceptance of the new keys

- **beat:** on beat
- **key:** on keystroke

FACTOR

Sets the beat ratio between BPM beat and steps (steps)

- **1** = All 4 Beats
- **1/2** = All 2 Beats
- **1/4** = All Beats
- **1/8** = 2 times pro Beat
- **1/16** = 4 times pro Beat
- **1/32** = 8 times pro Beat

ASSIGN

This menu tab sets the note, which was determined by the operation-dependent sorting of the keys, opposite the corresponding step (K1, K2, K3, K4, K5).

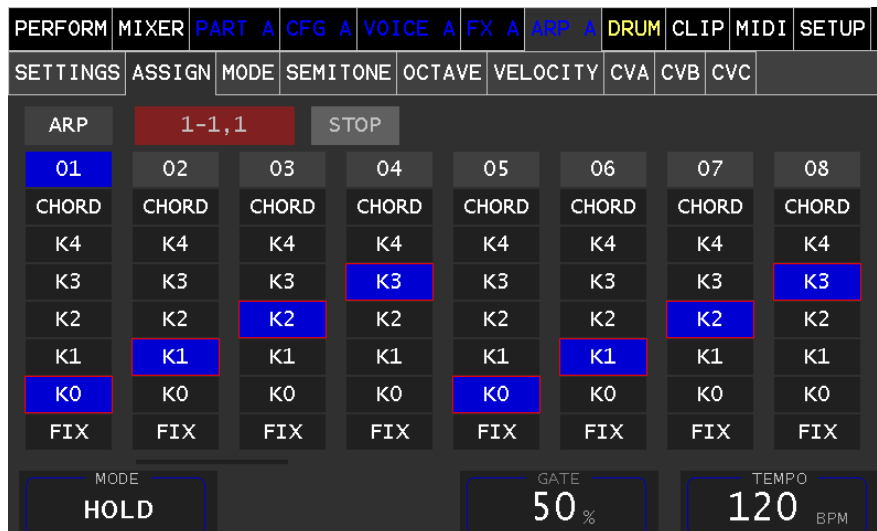

If not all keys are played, notes are played as substitutes according to the settings (Substitute).

CHORD plays all played notes on this step.

FIX (is for future extension).

MODE

This menu tab defines the Step Mode.

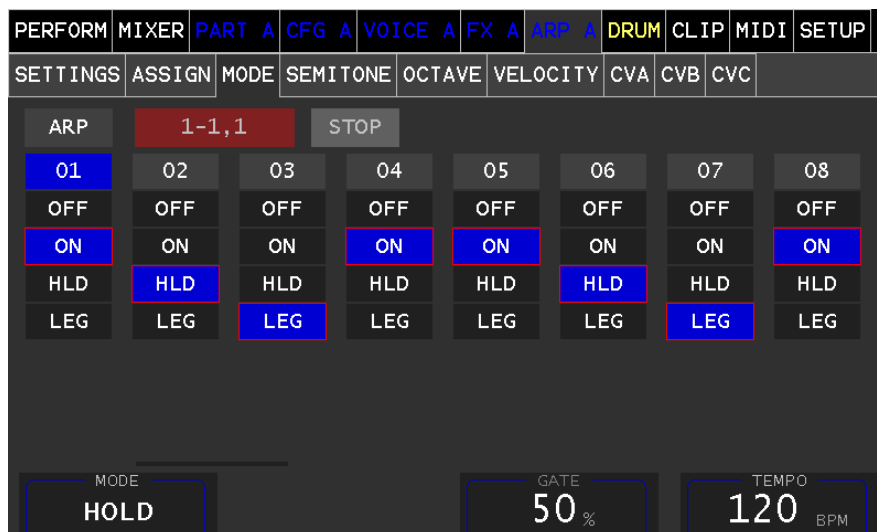

- **OFF:** No note is played in this step
- **ON:** In this step the note is played
- **HLD:** (Hold) extends the note from the previous step
- **LEG:** (Legato) only the pitch of the step will be taken over and there will be no new test stop

SEMITONE

This menu tab allows you to transpose the note value upwards in semitone steps.

From C = 0 semitones (no transposition) to B = 11 semitones

PERFORM	MIXER	PART A	CFG A	VOICE A	FX A	ARP A	DRUM	CLIP	MIDI	SETUP
SETTINGS	ASSIGN	MODE	SEMITONE	OCTAVE	VELOCITY	CVA	CVB	CVC		
ARP	1-1,1		STOP							
01	02	03	04	05	06	07	08			
+11	+11	+11	+11	+11	+11	+11	+11			
+10	+10	+10	+10	+10	+10	+10	+10			
+9	+9	+9	+9	+9	+9	+9	+9			
+8	+8	+8	+8	+8	+8	+8	+8			
+7	+7	+7	+7	+7	+7	+7	+7			
+6	+6	+6	+6	+6	+6	+6	+6			
+5	+5	+5	+5	+5	+5	+5	+5			
+4	+4	+4	+4	+4	+4	+4	+4			
+3	+3	+3	+3	+3	+3	+3	+3			
+2	+2	+2	+2	+2	+2	+2	+2			
+1	+1	+1	+1	+1	+1	+1	+1			
+0	+0	+0	+0	+0	+0	+0	+0			
MODE		HOLD		GATE		50%		TEMPO		121 BPM

OCTAVE

This menu tab allows transposition of the note value in octave up/down.



The note played depends on the root note of the corresponding step.

INFO

PERFORM	MIXER	PART A	CFG A	VOICE A	FX A	ARP A	DRUM	CLIP	MIDI	SETUP
SETTINGS	ASSIGN	MODE	SEMITONE	OCTAVE	VELOCITY	CVA	CVB	CVC		
ARP	1-1,1		STOP							
01	02	03	04	05	06	07	08			
4	4	4	4	4	4	4	4			
3	3	3	3	3	3	3	3			
2	2	2	2	2	2	2	2			
1	1	1	1	1	1	1	1			
0	0	0	0	0	0	0	0			
-1	-1	-1	-1	-1	-1	-1	-1			
-2	-2	-2	-2	-2	-2	-2	-2			
-3	-3	-3	-3	-3	-3	-3	-3			
-4	-4	-4	-4	-4	-4	-4	-4			
MODE		HOLD		GATE		50%		TEMPO		121 BPM

0 = corresponds to the note value of the step without transposition.

VELOCITY

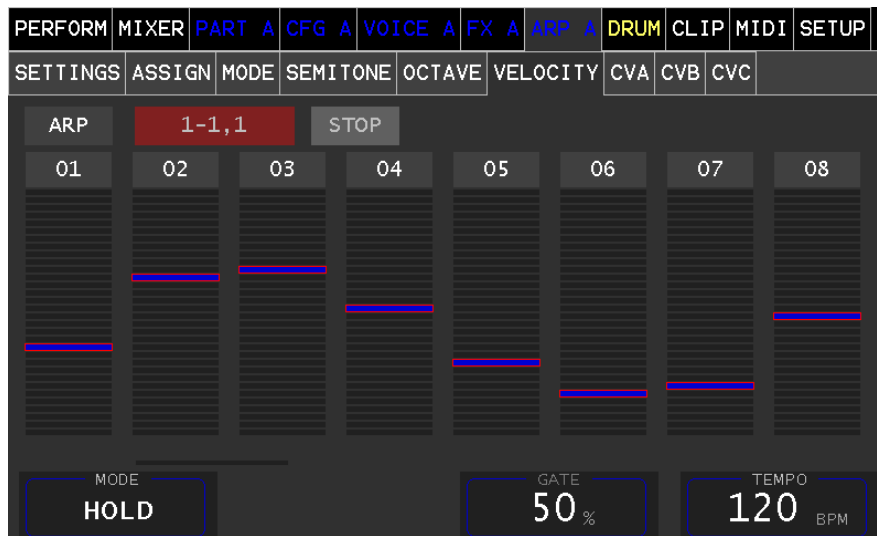

This menu tab sets the velocity value of the step with which the note is struck.



INFO

The preset must have the velocity setting in the envelope generators (EGs) enabled (0-100%) to have any effect.

CVA (B, C)

This menu tab allows to send a kind of virtual control voltage to the corresponding synth engine.

This allows step specific modulations. These virtual control voltages are found with the same name in the modulation matrix as a source and can be switched there.

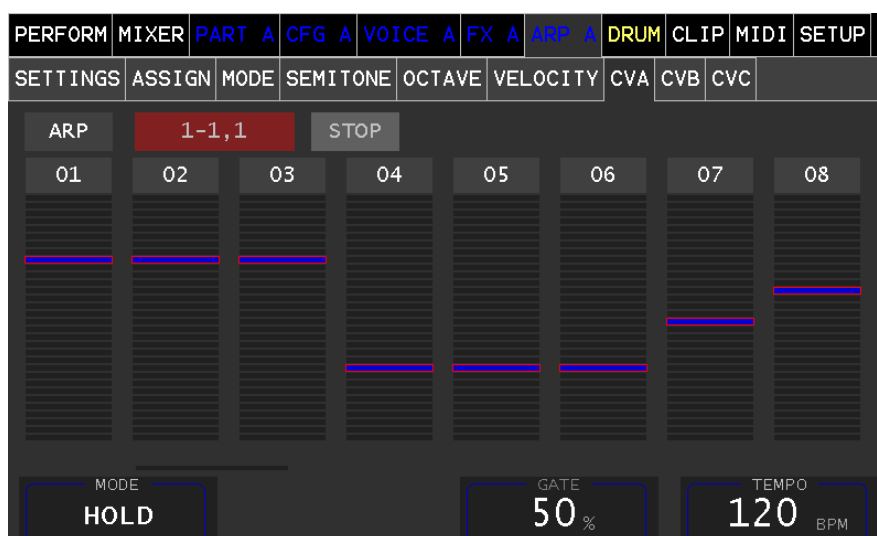

SEQ (MIDI-Sequencer)

The MIDI Sequencer can be opened via the Clip Launcher. To do so, select the Operation Open and touch the Clip you want to want to define a MIDI Sequence for. A new Tab named SEQ A (B, C, D, 1, 2) will open and show the Note Grid.

If no MIDI data is loaded, an empty Note Grid opens in the VIEW tab. We now select the MIDI FILE tab.

The MIDI file selection list shows all files that have been loaded into the file system (see chapter Import/Export). The length of the MIDI file is in quarter notes and is not automatically the end for the repeat (see LOOP).

IMPORT

The Import panel shows all standard MIDI-files are present in the folder "midfiles" in the Vibes MD850s filesystem. If a file is selected the details will be show. Pressing the **IMPORT** button imports the file into the MIDI-Sequencer Grid. The name from the MIDI file (not the file name) is taken as the clip name.

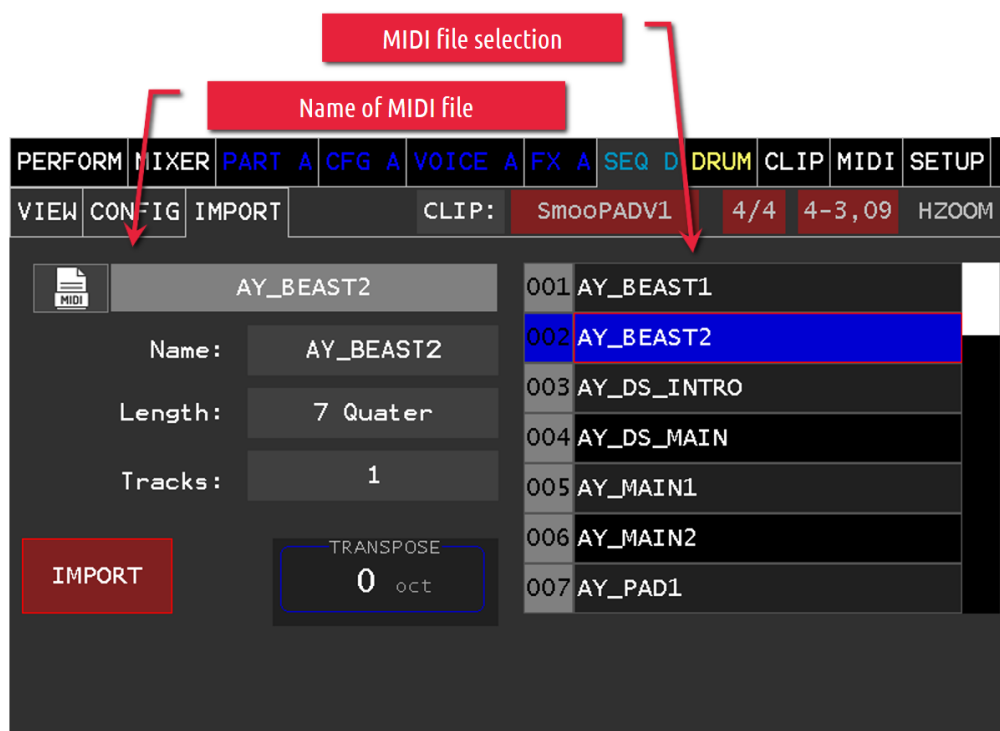

TRANSCOPE

Allows to transpose up to +3 octaves when importing

VIEW

In this view the MIDI events are displayed with the note values.

PANNING

Touch and drag the display to pan the note grid.

ZOOMING

Turn the selection wheel to zoom in and out. Pressing the selection wheel toggles between horizontal (time) and vertical (pitch) zooming.

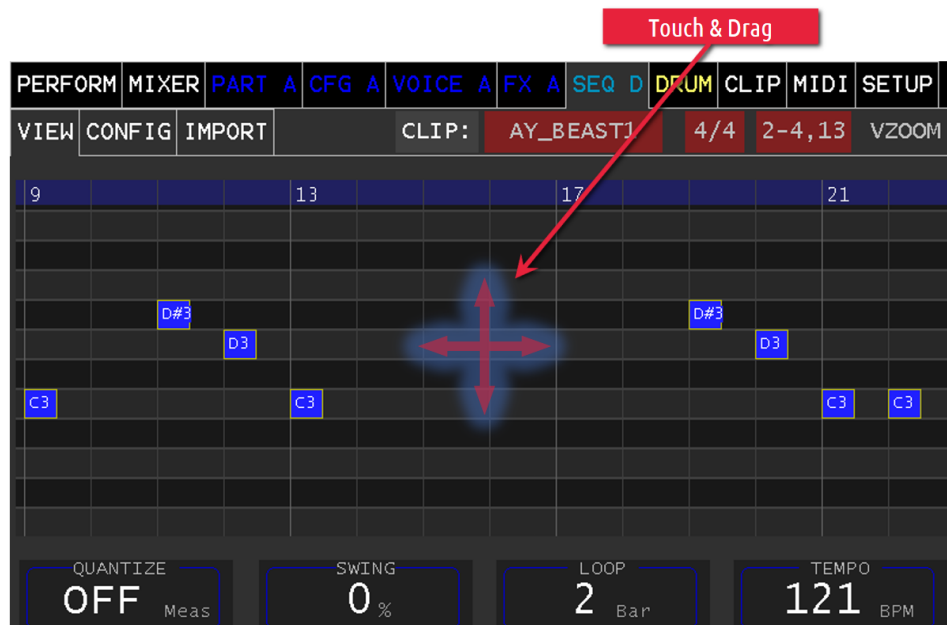

In case the displayed sequence is currently being played, the current position of the play head is visualized within the note grid.

QUANTIZE

With quantization the note will be automatically aligned to the rhythm. Example: 1/8 will align the Note to the closest 1/8 position

SWING

Swing will delay all notes on every second measure by a certain percentage relative to the measure. Positive values move them towards the next measure (100% equals moving them all the way to the next measure) while negative values, move them towards the previous measure.

LOOP

This parameter specifies the length in bars (BARs) where the looping takes place.

This should be an integer multiple of the TAKE-OVER bar (BAR) set in the Clip Launcher.

TEMPO

Determines the tempo in beats per minute (BPM)

CONFIG

reserved for future use

DRUM (Sample-Player)

The Drum Sample Player can be considered as an additional 5th part.

It allows to play up to 14 samples simultaneously without allocating any voices. This sample player is used for "one shot samples" (drum, percussion, noises etc.) and can be triggered by the internal "drum sequencer" or externally via MIDI channel 10. Therefore, we call it briefly **DRUM**.

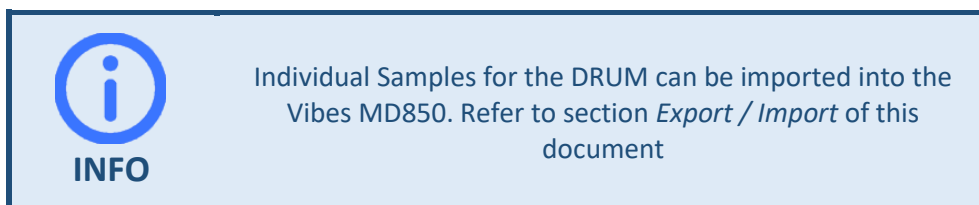

The 14 instruments are grouped for simplicity into 6 groups. Each instrument has its individual page to be configured.

GROUP	INSTRUMENT SUBPAGE	GRID SHORTCUT
KICK	KICK	k
SNARE	SNARE1	s1
	SNARE2	s2
HAT	CLHAT	cl
	OPHAT	op
CYMB	RIDE	rd
	CRASH	cr
TOM	TOM1	t1
	TOM2	t2
	TOM3	t3
PERCUSSION	PERC1	p1
	PERC2	p2
	PERC3	p3
	MISC	mi

The DRUM (Sample-Player) Menu consists of 3 Submenu Sections.

- 1.) KIT to load and store configurations of the Instrument Samples.
- 2.) GRID to define the pattern the instruments are triggered
- 3.) INSTRUMENTS pages to configure each of the 14 instrument samples

KIT

The drum kit groups the 14 instruments (e.g. kick, snare, hats, toms, percussions etc.) together with all their settings and sample selections.

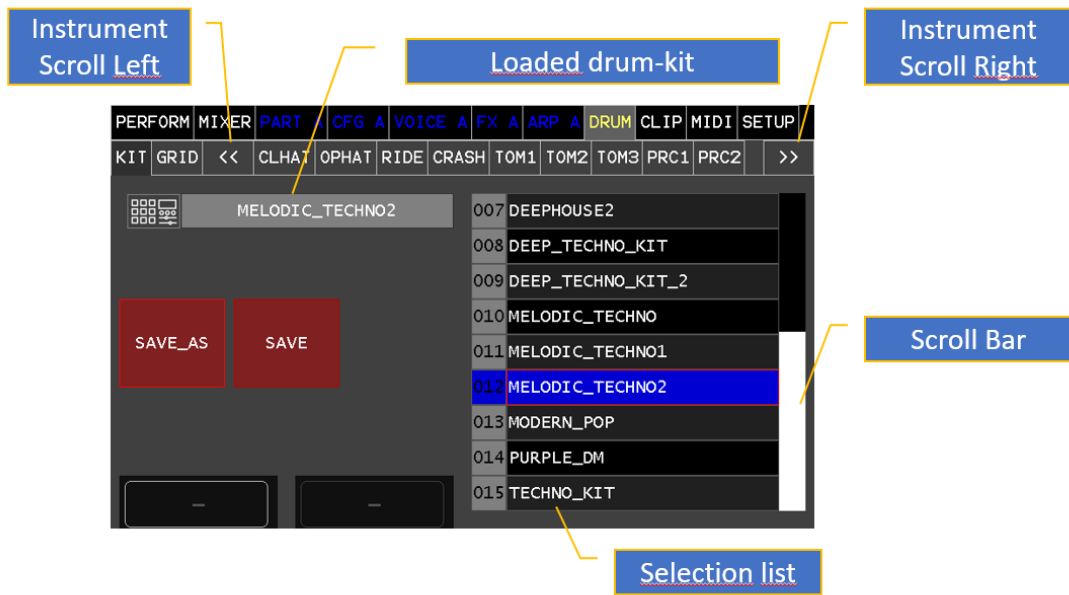

GRID

The DRUM Grid Editor allows to define a pattern to trigger the instruments (samples) defined in the DRUM KIT to be played.

The Grid is defined by 6 Instrument Groups and 16 Steps per page. To be able to handle more than 16 steps, the grid can be scrolled (using the Selection Wheel) to up to 3 more pages handling up to 64 steps.

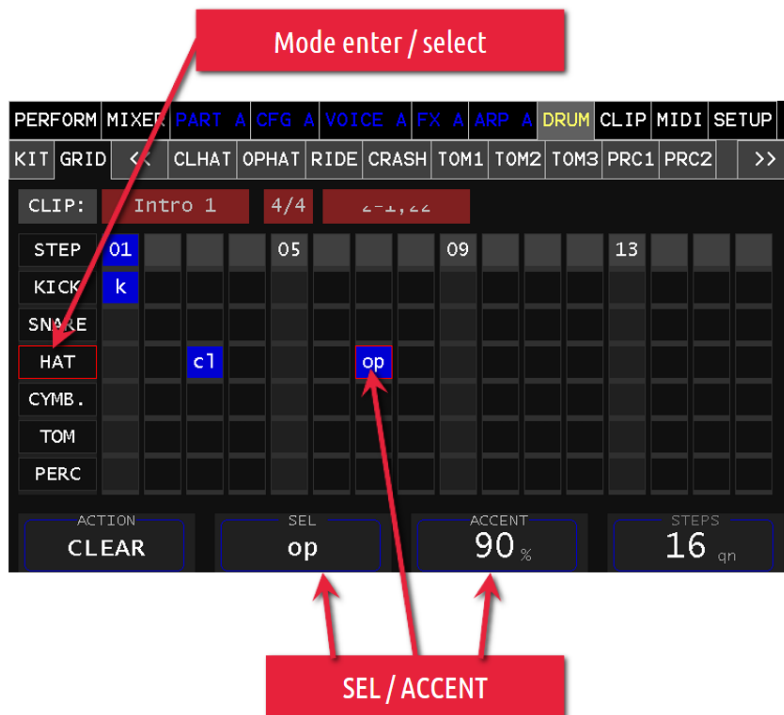

Multiple Drum Patterns can be defined and therefore special attention is needed which pattern is currently displayed and edited. The current Drum Pattern is displayed as CLIP.

To change the Drum Pattern being edited, change to the Clip Launcher via the main menu entry CLIP, select the Action Open (or CreateTrg) and select the Clip in the Track DRUM you want to edit.

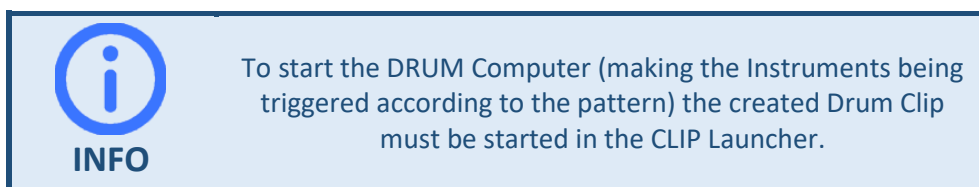

Enter / Select Mode

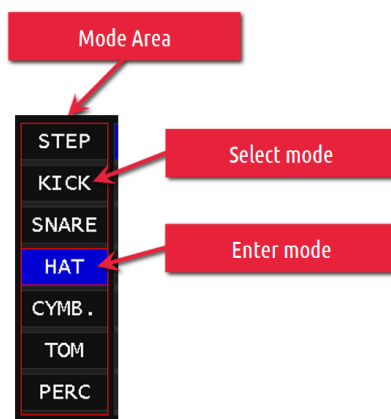

To distinguish between adding new Triggers (Enter) and selecting existing triggers for modification (Select) the grid can be toggled between Enter and Select Mode.

The mode can be toggled per individual Instrument by touching the Instrument Name or for the whole grid by Touching Step.

Adding/Removing Instrument Triggers

Make sure the Instrument you would like to add (or the whole grid) is in Enter Mode. Touching the step column of the corresponding instrument will add or remove the Trigger. The trigger will stay selected for immediate configuration (see next paragraph).

Editing an Instrument Trigger

Select the trigger you want to configure by putting the instrument or grid into Select Mode and touch the trigger.

Use the encoders to modify the parameters of the selected trigger.

SEL

Selects the instrument to be triggered with the currently selected trigger. Since there are multiple instruments combined in a group represented by single row, you can select between multiple different instruments to be triggered (see table at the beginning of this chapter for more details on the grouping).

ACCENT

Defines the velocity of the currently selected trigger.

Other Parameters

ACTION

With the help of the ACTION parameter it is possible to perform various actions (pressing the Encoder knob) on all triggers in Enter Mode

- CLEAR: Deletes all Triggers in Enter Mode
- MUTE: Mutes all Triggers in Enter Mode

STEPS

The STEPS parameter defines the number of steps until the pattern is looped. If more than 16 steps are set, the selection wheel can be used to scroll to the next page(s).

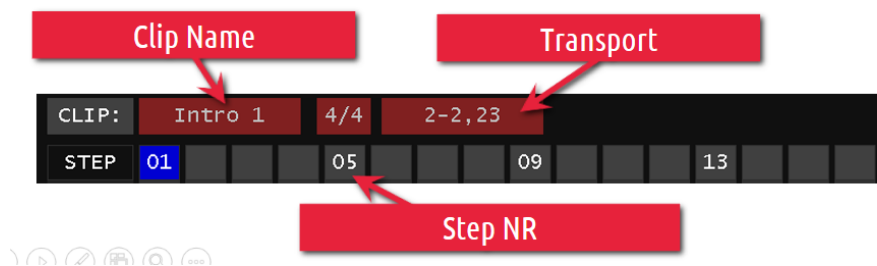

Pattern-Duplication

Pressing Encoder 4 (Encoder below the Step Parameter) will automatically duplicate the triggers from the previous page to the currently viewed page (be aware, triggers already defined will be removed from the page).

Example: To extend the steps and duplicate the pattern simply increase the step parameter, scroll to the new page using the selection wheel and press Encoder 4. The pattern from the previous page will be duplicated and is ready for modification.

INSTRUMENTS

Each instrument has its individual configuration page, allowing to define the sample used for this instrument and manage its configuration.

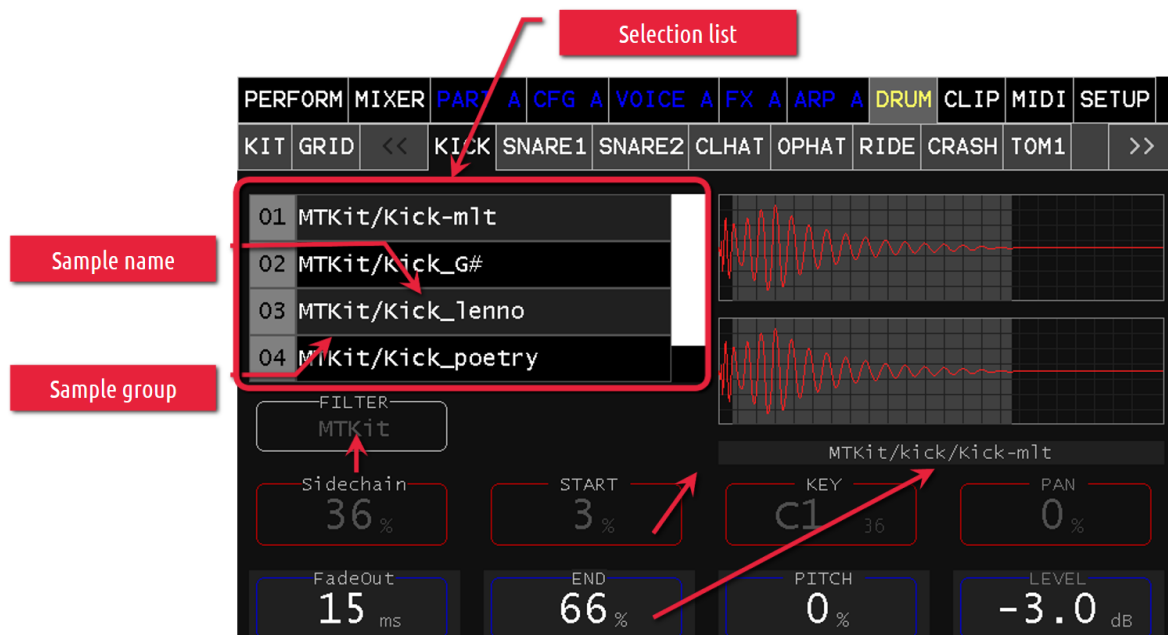

FILTER

By means of this parameter the selection list can be filtered by sample groups.

Sidechain

This parameter allows mixing these instruments to the sidechain bus. This bus can be processed in the effect section of the PARTs or MIXER. (e.g. Dynamic Compressor)

FadeOut

Specifies the fadeout time (END) in milliseconds.

START

Start point selection in % (total length). The system automatically tries to set this start point as close as possible to a zero crossing.

END

End point selection in % (total length). It is automatically tried to set this end point as close as possible to a zero crossing. In addition, the signal is faded out during the set time (fadeout).

PITCH

Change the output frequency in % relative to the sample base frequency.

KEY

Sets the MIDI note on which this instrument can be triggered by MIDI channel 10.

PAN

Defines the stereo Panorama of this instrument from left (-100%) to right (+100%). This parameter is directly linked to the Mixer Balance Parameter of the according instrument.

LEVEL

Defines the Volume Level of this instrument in dB. This Parameter is directly linked to the Mixer Level Parameter of the according instrument.

CLIP (Clip-Launcher)

The Clip Launcher, Menu Tab CLIP, is the central hub for performing live directly with the Vibes MD850.

It allows to play (start, stop, ...), manage (create, edit, remove, ...) and record Clips.

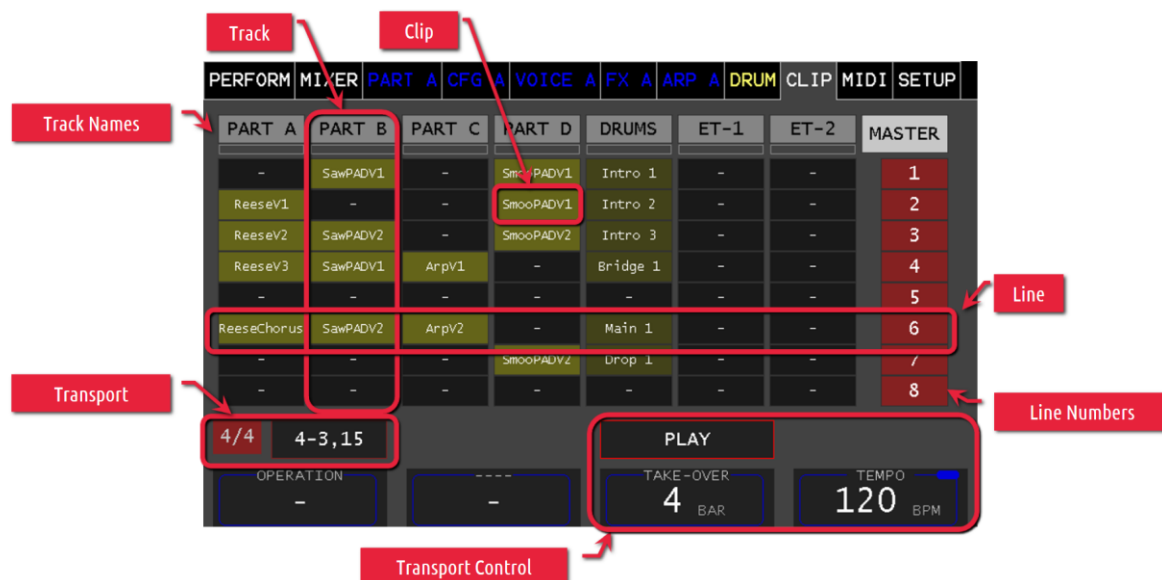

Clip

Clips are basically a piece of looped musical material. It can either be a melody in form of a MIDI Sequence or a rhythm in form of Drum Pattern. The clip page is therefore organized in vertical columns called tracks, and horizontal rows called lines.

Track

Each track represents the sound creating component being triggered by the clips of that track. This can either be the 4 Parts of the Vibes MD850, the Drum Computer or two external Devices triggered by MIDI Events via the DIN-MIDI out at the Tracks ET-1 and ET-2.

Each clip can be started and stopped individually. But since all clips within a track trigger the same component, only one clip per track can be played at any time.

Line

Each line represents an arrangement of clips from different tracks (4 Synth Parts, Drums and 2 External Tracks) usually but not necessarily being played together.

Transport

Since playing multiple clips together needs some kind of conductor to keep timing, clips are not started at any point in time, they are all synchronized to the transport instead. The transport defines the time behavior and the measure and therefore needs to be managed via the transport controls (Stop and Play).

Playing the Clip Launcher



We assume the Clip Launcher is already prepared with Clips (for details on how to load a performance see *Loading a Performance*) so we can start our session.

Start an individual Clip: touch the stopped clip to start playing the clip

Start all Clips in a line: touch the line number to start playing all the clips in a line

After touching the clips, they will first wait for the proper time to start playing, signaled by a green blinking state of the clip. As soon as the transport wrapped, the clip will start playing, signaled by a full green background of the clip.



WARNING

If the transport is not started, or configured to an external MIDI clock without the clock being present, the clip will remain in “Waiting” state forever. (see the paragraph below on how to start/stop the Transport)

Transport Controls

The current status of the transport is shown at the bottom left corner of the page. The playhead is progressing according to the Tempo or, if enabled, according to the MIDI Clock on the DIN MIDI IN Port. In case the position is not moving, the Transport is either stopped or no MIDI Timing Clock Messages are received.

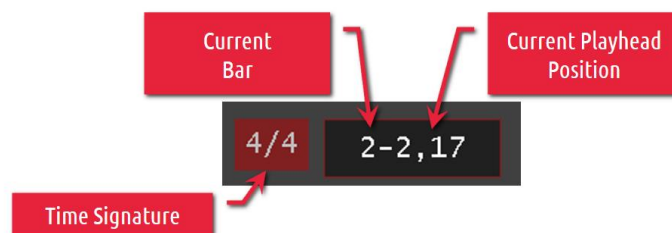

PLAY/STOP Button

Starts or Stops the Transport



Transport is currently running (touch to stop)



Transport is currently stopped (touch to start)

To control the Transport (Start/Stop/Continue) via MIDI Control Messages, activate the Transport Controls on the MIDI Clock Page (see chapter *MIDI Clock* for more details)

TAKE-OVER

This parameter determines the number of measures (bars) until a selected clip is started/taken over.

TEMPO

This parameter determines speed of the transport in beats per minute (BPM). The clock is either created internally or synchronized to an external MIDI clock signal. It is always global and also used by other functionalities of the Vibes MD850 (see *MIDI Clock* for more details).

Editing the Clip Launcher

You can do various operations on the clip (or clip slot) by using the Operation Encoder. Select the Operation first, and touch the clip (or empty clip slot) to apply the operation. Repeat for other clips/clip slots if needed.

The operation is automatically reset to its default (Start / Stop Playing) if no clip is touched to apply the operation within a few seconds (except the Open Operation, see below).

- **Open:** enables open mode, touch on a certain clip will open the underlying sequence or drum pattern in the according editor. This operation remains active until other operation is selected
- **ARM-Record:** activates the recording of the selected track (touch the track name instead of a clip – see below for more details)
- **Clear:** empties all MIDI-Events of a CLIP
- **CreateSeq:** Creates a MIDI Sequence (to be edited in the MIDI Sequencer – see *VIEW* for more details)
- **CreateTrg:** Create a drum pattern (to be edited in the Drum Grid – see *GRID* for more details)
- **Name:** Name or Rename a CLIP
- **Copy:** Copies a Clip to the clipboard
- **Paste:** Copies the Clip from the clipboard to the selected slot (overwrites existing Clip)
- **Delete:** Removes a CLIP from the slot

Recording with the Clip Launcher

Instead of importing a MIDI Sequence from a MIDI File, you can directly record the MIDI note events into the MIDI Sequencer.

To do so, first select the Operation ARM-Record with Encoder 1. Select the Track you want to arm by touching the Track Name. The Track turns Red to signal its armed state.

The recording starts as soon as a clip of the armed track is started by a touch. A clip which is already playing while arming the track, will require a restart (stop and start) of the track to start recording.

The clip will signal its recording state with changing its background to red. You can start pressing the keys (sending MIDI Note Events) to be recorded.

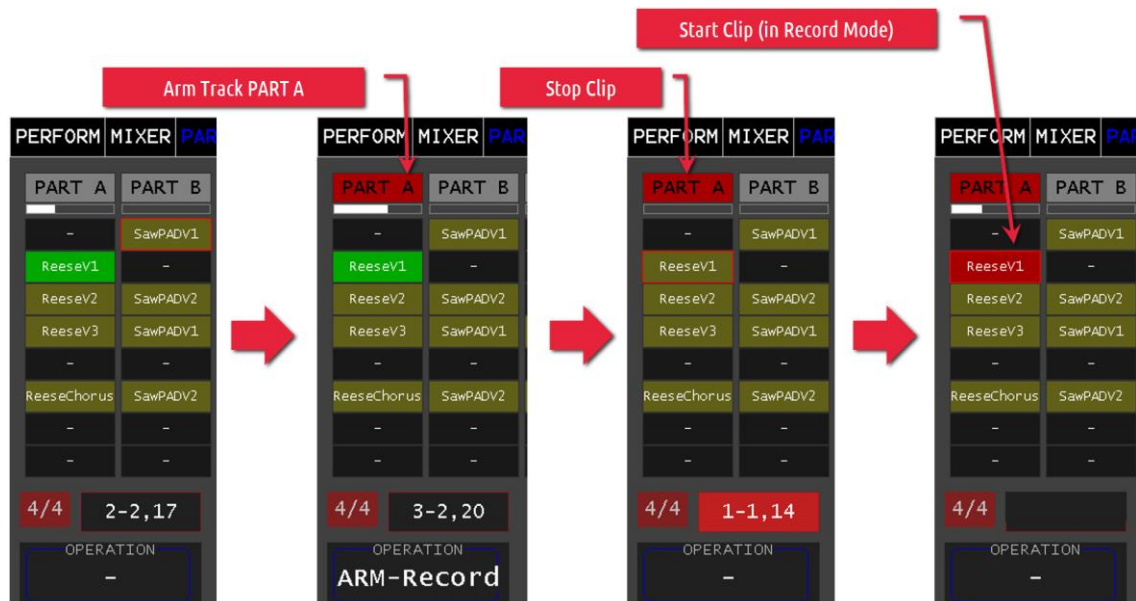

For more recording options, open the editor (Operation Open) of the clip.

MIDI (MIDI Settings)

MIDI Clock

In the MIDI Subpage CLOCK allows you to configure the handling of MIDI Timing Clock and MIDI Transport Messages in your Vibes MD850.

Per default your MD850 is generating its Master Clock internally and distributing it to all components which are making use of a clock (Clip Launcher, MIDI Sequencer, Drum Computer, Arpeggiator, LFOs (if set to SYNC), ...).

Alternatively, your Vibes MD850 can synchronize its Master clock to a MIDI Timing clock on the DIN MIDI IN Port.

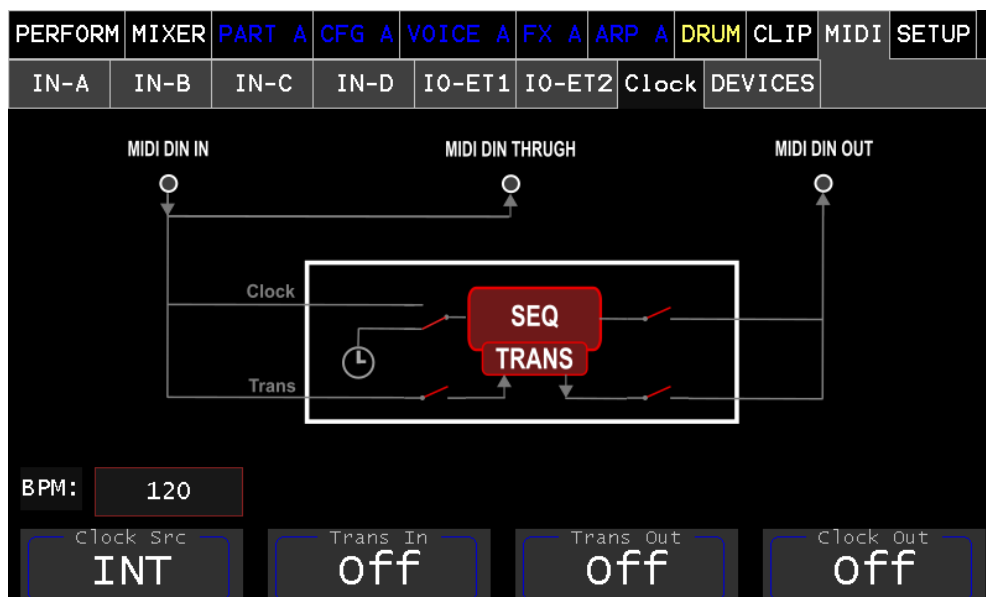

Clock Src

- **Int:** creates the Master clock based on the internal timer of the Vibes MD850
- **Ext:** synchronizes the Master clock to the MIDI Timing Clock Messages (System Realtime Message F8H) on the DIN MIDI IN Port. For clock stability, the synchronization averages the clock over messages.

The current rate of the Master Clock can be checked in the bottom left corner.

Trans In

Defines if the Vibes MD850 reacts to the MIDI Transport Messages on the DIN MIDI IN Port.

- **Off:** MIDI Transport Messages are ignored
- **On:** the following MIDI Transport Messages are processed by the Vibes MD850:
 - MIDI Start (System Realtime Message FAH) to Start the Clip Launcher
 - MIDI Continue (System Realtime Message FBH) to Start the Clip Launcher
 - MIDI Stop (System Realtime Message FCH) to Stop the Clip Launcher

Trans Out

Defines if MIDI Transport Messages are forwarded from the DIN MIDI IN to the DIN MIDI OUT Port and if MIDI Transport Messages are sent on the DIN MIDI OUT Port.

- **Off:** MIDI Transport Messages are not forwarded or created
- **On (when TRANS IN is On):** the following MIDI Transport Messages are forwarded:
 - MIDI Start (System Realtime Message FAH) to Start the Transport
 - MIDI Continue (System Realtime Message FBH) to Start the Transport
 - MIDI Stop (System Realtime Message FCH) to Stop the Transport
- **On (when TRANS IN is Off):** the following MIDI Transport Messages are sent:
 - MIDI Start (System Realtime Message FAH) when the Transport is started (via the Transport Controls in the Clip Launcher or via the Play Key on the front panel)
 - MIDI Stop (System Realtime Message FCH) when the Transport is stopped (via the Transport Controls in the Clip Launcher or via the Play Key on the front panel)

Clock Out

Defines if the Transport Clock is sent out on the DIN MIDI OUT Port.

MIDI Devices

If a connected USB MIDI keyboard is to be used, the USB device must first be linked (mapped) to a MIDI port (P1-P4). This allows the assignment to a part (A-D) via the MIDI Input tabs.

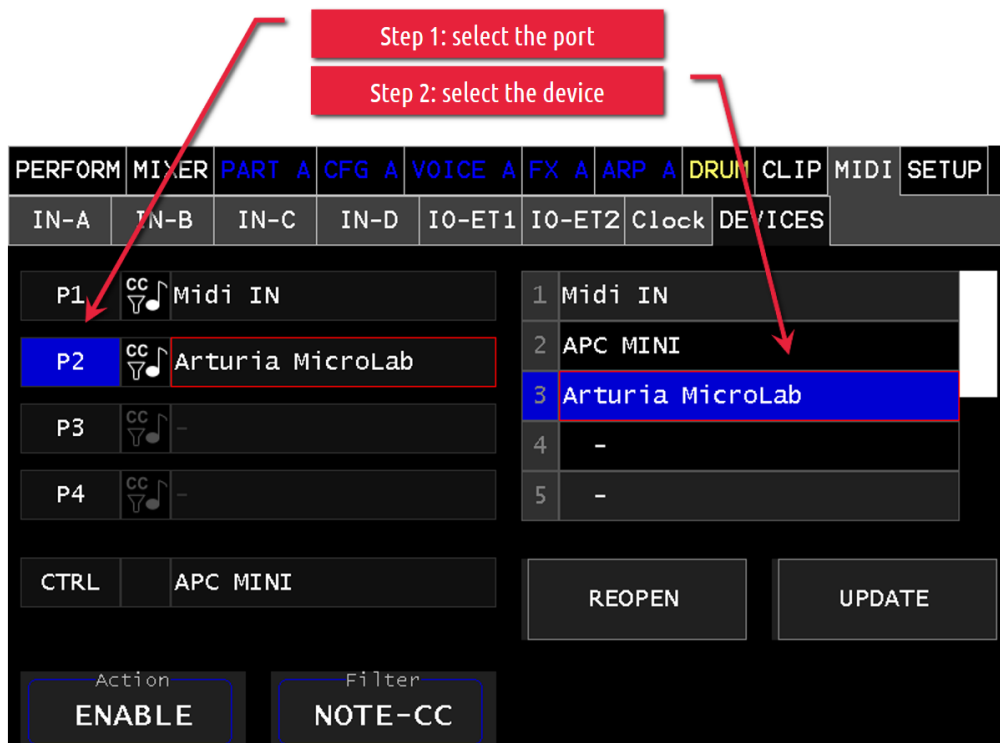

In the default settings the DIN-MIDI IN is assigned to Port P1. To assign the connected USB-MIDI device go to the tab MIDI-Devices. Pressing the UPDATE touch button updates the Devices list (right).

MIDI Inputs

In the MIDI tab the MIDI routing configuration will be setup. To assign a MIDI Input (Port & Channel) select one of the sub-tabs **IN-A, B, C, D, IO-ET1, IO-ET2**. Additional settings are adjustable for the MIDI Input in this view.

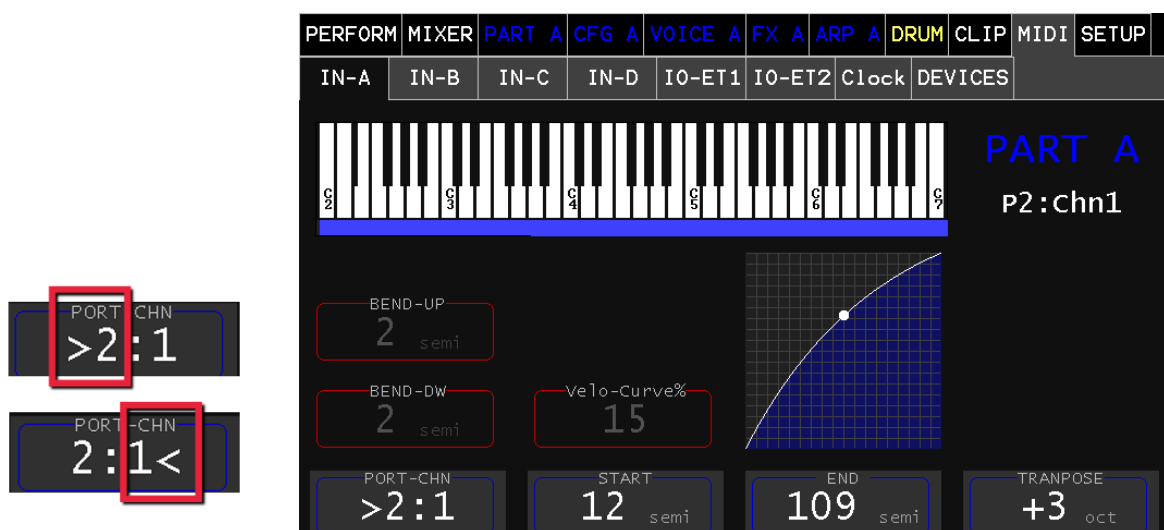

The LABEL: **PORT-CHN** allows the selection of the port (e.g. P2). Pressing the encoder key switches between port & channel. This is indicated by ">" or "<".

START, END

Sets the active range where this part accepts note ON/OFF messages (this is useful for splitting the keyboard)

TRANSDPOSE

shifts octave-wise upwards

BEND-UP

sets the pitch bend range upwards in semitone steps

BEND-DW

sets the pitch bend range down in semitone steps

Velo-Curve

MIDI velocity correction curve

SETUP

DIAGNOSTIC

The Diagnostic Page of your Vibes MD850 gives you an overview about the current Status and Performance of your synthesizer as well as allowing to diagnose received MIDI messages.

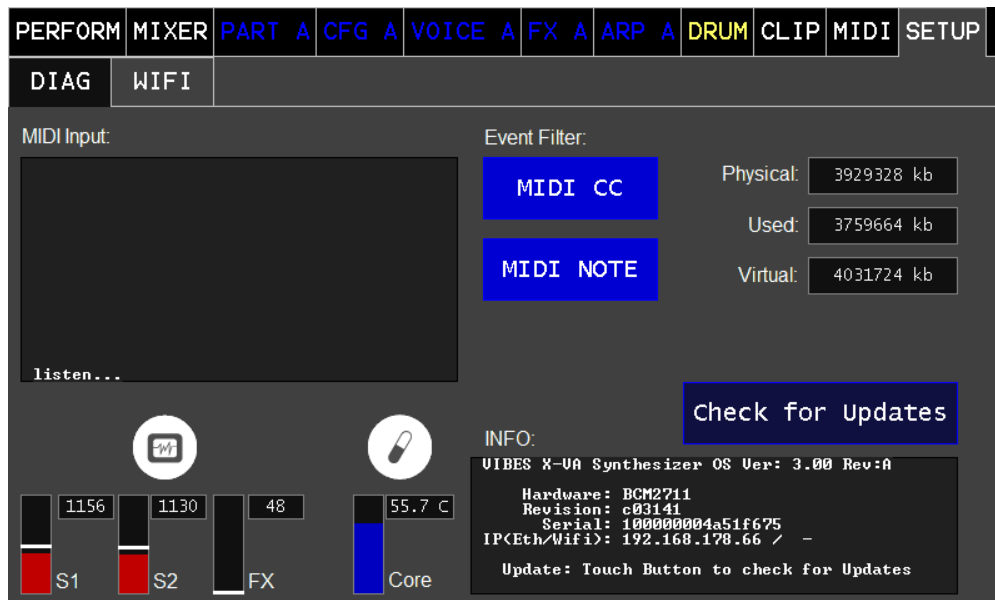

MIDI Input

This Box lists all the received Midi Messages. It helps to verify on which channels your connected MIDI Devices are communicating for example. With the Event Filter, you can filter out MIDI CC or MIDI NOTE Events. (MIDI Clock Events are generally not listed)

Performance Monitor

Gives Information about the current CPU Utilization and Core Temperature of your Vibes MD850.

INFO

Gives Information about your Vibes MD850 and its current Software Version.

If Ethernet and/or Wifi are connected, you will be able to see the (from DHCP) received IP Addresses.

The last line shows the Status About the Software Update (Button Check for Updates)

WIFI

The Vibes MD850 is equipped with a built in Wi-Fi Module allowing you to connect to 2.4GHz and 5.0GHz IEEE 802.11b/g/n/ac networks.

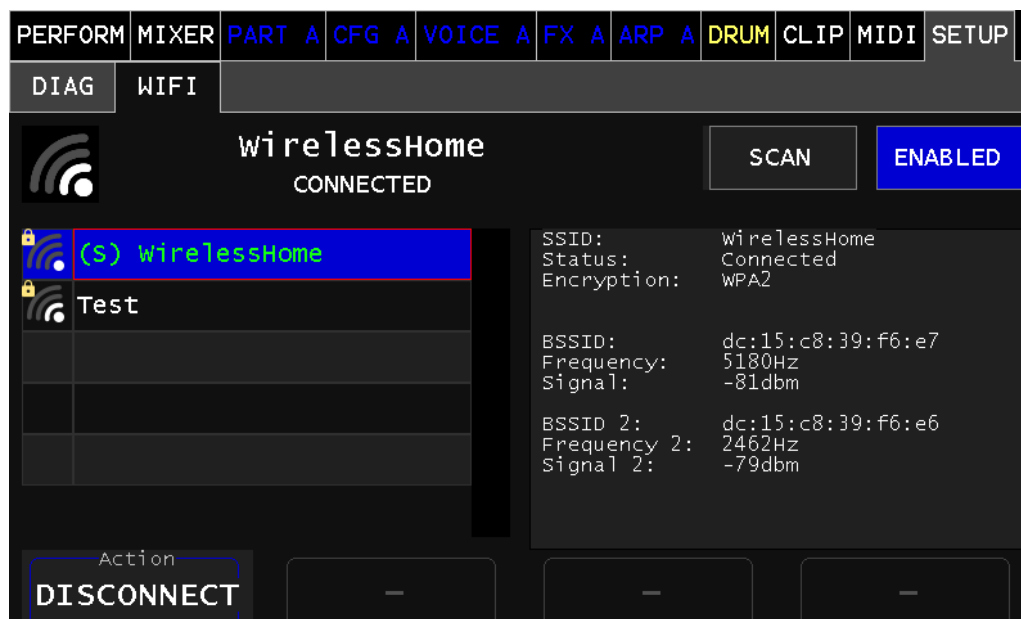

The SETUP -> WIFI page allows you to manage your Wifi Connection.

Enable/Disable Wifi

Use the ENABLE/DISABLE button to enable or disable the Wifi Module. When the Wifi Module is disabled, the radio will not be active and therefore cannot connect or scan any Wifi Networks.

Scan for Wifi Networks

When the Wifi Module is enabled, you can start Scanning for Wifi Networks with pressing the SCAN Button. The Scanning process can take up to a few seconds. After finishing the scan, the List of Networks will be updated with the scan results.

Selecting a Wifi Network from the list by the use of the touch display or the main wheel, will show you more detailed information about the selected Wifi Network in the Information Box.

Connect to a Wifi Network

Select a Wifi Network from the list. Use Encoder 1 to select the Action CONNECT and press the encoder to execute the action. (In case you are already connected to the Wifi, this option will not be available)

The on screen keyboard will ask for the passphrase in case the selected network is encrypted. Enter the passphrase and confirm.

The Vibes MD850 will connect to the Wifi and will be shown as the currently connected Wifi. Additionally, the Wifi will be saved with its passphrase, leading to an automatic connect to this network in the future (e.g. after a reboot or relocation).

In case the passphrase is not correct, the connection will fail. Remove the Network (see below) and reconnect to be able to change the passphrase.

Remove Wifi Networks

To remove a Wifi Network and its passphrase from the list of saved networks, select the Wifi in the list and use Encoder 1 to select the Action "REMOVE".

Limitations

Currently the connection via Wifi is limited to Networks which use the following (most common) encryptions:

- Open / No Encryption (not recommended)
- WPA2-PSK

The following modes are not supported:

- Connecting to Networks with Hidden SSIDs
- Connecting to Networks with non-standard compliant passphrases (8 to 63 letters, ASCII 32-127)
- WEP or WPA encrypted networks (unsecure)
- Pure WPA3-SAE encrypted networks
- Non PSK Authentication (Radius, etc.)
- Authentication via Captive Portals

Export / Import

The Vibes MD850 is equipped with an internal memory organized as a filesystem to save (beside its own software) all necessary resources to create sounds. This filesystem can be accessed via multiple ways to allow you to import and export the following resources

- Presets
- Performances
- Midi Sequences
- Wavetables
- Samples for MultiSample/Noise Oscillator
- Samples for Drum Computer

USB

The Vibes MD850 can mirror its resources onto a plugged USB Stick.

Web Interface

To use the Web Interface, connect your Vibes MD850 to a Router (either via a wired Ethernet Connection or by use of the built in Wi-Fi). Connect a Laptop to the same Router and open a Browser.

Enter the Vibes MD850s IP Address into your Browser (see INFO Box in the DIAG Menu) to get to the Login Page of the Web Interface.

Use the following credentials for your first Login:

Username: Vibes

Password: emi

Software Updates

The Vibes MD850 is regularly updated with new features, sound packs and other improvements via software updates.

There are two possibilities to update your Vibes MD850 to the latest software version.

Online Update

Use either a wired Ethernet Cable or the built-in Wi-Fi to connect your Vibes MD850 to a Router. As soon as the connection is established you can use the Check for Updates Button in the SETUP -> DIAG Page to check for new updates.

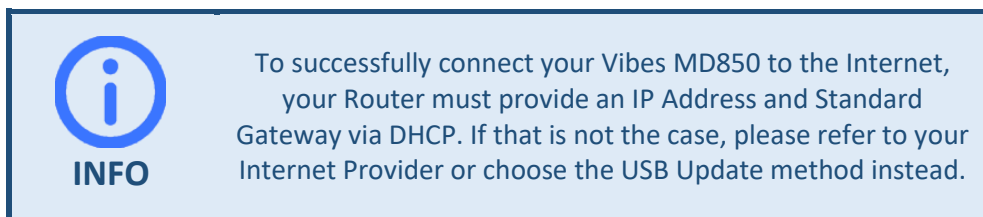

In case there are updates available, the Info Box will show the new available Version. Touching Download will download this version to your Vibes MD850 (the Info Box will inform about the Download Progress).

As soon as the Download is finished, a touch on Install will stop the Synthesizer Software and start the installation process which will finish with a restart of the Software.

After a successful update, the Info Box will show you the latest Version.

USB Update

In this update method a common USB Stick is used to update your Vibes MD850 to the latest Version. Get the currently Version Number of your Vibes MD850 Software from the Info Box on the SETUP -> DIAG Page.

Visit <https://mayer-emi.at/support> to check if there is a newer Version available. If so, follow the instructions on the webpage to install this Version.

Mayer EMI GmbH
Franz Prendinger Straße 74
2540 Bad Vöslau | Austria

Version 1.1 - EN
© 2024 Mayer EMI GmbH
All rights reserved

<https://mayer-emi.at>